

INSTRUCTIONS FOR USE

# Sara Plus



## **WARNING**

**To avoid injury, always read this Instructions for Use and accompanied documents before using the product.**



**Mandatory to read the Instructions for Use**

Design Policy and Copyright

® and ™ are trademarks belonging to the Arjo group of companies.

© Arjo 2021.

As our policy is one of continuous improvement, we reserve the right to modify designs without prior notice. The content of this publication may not be copied either whole or in part without the consent of Arjo.

# Contents

<b>Foreword</b> .....	2
<b>Intended use</b> .....	3
<b>Safety instructions</b> .....	4
<b>Preparations</b> .....	5
Actions before first use .....	5
Actions before every use .....	5
In between use .....	5
Sara Plus directions .....	5
<b>Parts designation</b> .....	6
<b>Product description</b> .....	7
Allowed slings with Sara Plus .....	9
Commode seat (Accessory) .....	10
<b>How to use the Sara Plus</b> .....	12
General .....	12
Prepare Sara Plus and patient .....	12
Use the Standing sling for transfer .....	13
Use the Transfer/Walking sling for transfer .....	15
Use the Transfer/Walking sling for walking .....	17
Arjo scale (if available) .....	18
<b>Battery Instructions</b> .....	18
Battery discharge indicator .....	18
Charge the battery .....	19
<b>Cleaning and disinfection</b> .....	21
<b>Care and preventive maintenance</b> .....	22
Preventive maintenance schedule .....	23
<b>Troubleshooting</b> .....	24
<b>Technical specification</b> .....	25
<b>Dimensions</b> .....	27
<b>Labels on the Sara Plus</b> .....	28
<b>Electromagnetic Compatibility</b> .....	31

# Foreword

---

Thank you for purchasing Arjo equipment.

## *Customer contact information*

For questions regarding this product, supplies, maintenance, or additional information about Arjo products and service, please contact Arjo or an Arjo authorized representative, or visit [www.arjo.com](http://www.arjo.com).

## *Please read and fully understand these Instructions for Use (IFU) before using Sara Plus*

Information in this *IFU* is necessary to perform the operation and maintenance of the equipment. It will help to protect your product and make sure that the equipment performs to your satisfaction. The information in this *IFU* is important for the safety of both patient and caregiver and must be read and understood to help prevent possible injury.

Unauthorized modifications on any Arjo equipment can affect safety. Arjo will not be held responsible for any accidents, incidents or lack of performance that occur as a result of any unauthorized modification to its products.

## *Support*

If you require further support, please contact Arjo for comprehensive support and maintenance to maximize the long-term safety, reliability and value of the product. Contact your local Arjo representative for spare parts. The telephone numbers appear on the last page of this *IFU*.

## *Serious incident*

If a serious incident occurs in relation to this medical device, affecting the user, or the patient then the user or patient should report the serious incident to the medical device manufacturer or the distributor. In the European Union, the user should also report the serious incident to the Competent Authority in the member state where they are located.

## *Definitions in this IFU*



### **Warning**

This means failure to understand and obey this warning may result in injury to you or to others.



### **Caution**

This means failure to follow these instructions may cause damage to all or parts of the system or equipment.

### **Note:**

# Intended use

---

## Intended use for *Sara Plus*

The *Sara Plus* is a standing and raising aid for short transfers of residents/patients e.g. raising from bed and transfer to wheelchairs, or from wheelchair to toilet. This equipment is also suitable for rehab exercises including walking training when the footboard and kneepad are removed. Transfers with the *Sara Plus* are made indoors in the resident's/patient's room, treatment rooms, in communal areas or in a bathroom.

The *Sara Plus* is intended to be used in hospitals, nursing homes or other health care facilities for different categories of residents/patients.

The *Sara Plus* shall always be handled by a trained caregiver, continuously attending to the resident/patient, and in accordance with the instructions outlined in the *Instructions for Use (IFU)*.

The *Sara Plus* is intended to be used with specifically designed Arjo slings.

When using the transfer/walking sling for the transfer, the Safe Working Load is 140 kg (308 lbs). When using the same sling for walking practice the Safe Working Load is 190 kg (420 lbs).

The *Sara Plus* should only be used for the purpose specified in the *IFU*. Any other use is prohibited.

### *Patient assessment*

Before attempting to use *Sara Plus*, a full clinical assessment of the resident/patient condition and suitability must be carried out by a qualified person.

The *Sara Plus* is intended for the resident/patient who:

- Sits in a wheelchair
- Is able to partially bear weight on at least one leg
- Has some trunk stability
- Is dependent on the caregiver in most situations
- Needs mobility-maintaining standing exercises

When used in combination with an EPS (Extra Postural Support)/BOS sling (Buttocks support standing sling) and only for raising and transferring purpose, the *Sara Plus* is intended for the resident/patient who:

- Sits in a wheelchair
- Is dependent on the caregiver in most situations

If the resident/patient does not meet these criteria an alternative equipment/system shall be used.



**Caution:** Although manufactured to a high standard the *Sara Plus* and its accessories should not be left for extended periods in humid or wet areas.

Do not under any circumstances spray the *Sara Plus* or accessories (excluding slings) with water e.g. under a shower.

## *Expected service life*

The expected service life is the maximum period of useful life as defined by the manufacturer.

The expected service life of the *Sara Plus* is ten (10) years from the date of manufacture, providing the following conditions are adhered to:

- The unit is cared for and serviced in accordance with “*Cleaning and disinfection*” and “*Care and preventive maintenance*”.
- The unit is maintained to the minimum requirements as published in the “*Preventive maintenance schedule*”
- The servicing and product care, in accordance with Arjo requirements, must begin on first use of the unit by the customer.

For expected service life for slings please refer to the *IFU* for the respective sling.

The expected service life for consumable products, such as batteries, fuses, seal kits, seat inserts, safety belts, padded covers, straps and cords is dependent upon the care and usage of the equipment concerned.

Consumables must be maintained in accordance with “*Cleaning and disinfection*” and “*Care and preventive maintenance*”.

The equipment is not suitable for use if it is damaged.

# Safety instructions

---



**Warning:** Before using the *Sara Plus*, a qualified health professional must carry out a clinical assessment of the patient to make sure that the patient is clinically able to perform activities.



**Warning:** This equipment must only be operated by caregivers who have been trained in the correct use of this equipment and have read and understood the *IFU*.



**Warning:** Some of these parts are safety critical to the operation of the lift and needs examining and servicing on a regular basis and must be replaced when necessary. See “*Care and preventive maintenance*” section.



**Warning:** When using the transfer/walking sling for the transfer operation the maximum lifting capacity is 140kg (308lbs). When using the same sling for walking practice the maximum lifting capacity is 190kg (420lbs). Do not exceed these weight limits.



**Warning:** To avoid serious injury, the patient must limit extended reaching or leaning movements while in the *Sara Plus*.



**Warning:** It is advisable to familiarise yourself and understand the operation of the various controls and features of the *Sara Plus* as described in “*Product Description*” section in this manual and make sure that any action or check specified is carried out before commencing to lift a patient.

If you require assistance in the setting up, use or maintenance of the *Sara Plus*, or if you experience any unexpected operation while using it, please contact your local Arjo office. A list is given inside the back cover of this manual.



**Warning:** This equipment includes small parts that may present a choking hazard to small children if inhaled or swallowed.

Keep children and pets away from the equipment.



**Warning:** The hand control cable presents a possible strangulation risk. Take all necessary precautions to prevent this.



**Warning:** The caregiver should not touch the connector of the hand control and the patient simultaneously.

# Preparations

## *Actions before first use (4 steps)*

1. Visually check the package for damage. If the product looks damaged due to freight, contact the transport agency.  
Do NOT use the product.
2. Recycle the packaging according to local regulations.
3. Read this *IFU*.
4. Choose a designated area, where this *IFU* should be kept and is easily accessible at all times.
5. Unpack the battery pack supplied and fully charge it, see section “*Charge the battery*”.

## *Actions before every use (4 steps)*

1. Visually inspect *Sara Plus*. If any part is damaged - do NOT use the product.
2. Check the battery level.
3. Make sure the green reset button (situated on the rear of the mast) is pressed i.  
(See Fig 2 on page 7 in section “Parts Designation”)
4. Check that the system failure lower override knob is turned fully clockwise and finger tight.

## *Between patients*

Clean and disinfect the product according to section “*Cleaning and Disinfection*”.

## *Sara Plus directions*

### **Left and right**

*Sara Plus* has a left and a right side. (See Fig 1)

### **Transfer directions**

The caregiver must be positioned behind the *Sara Plus* during the transfer. (See Fig 1)

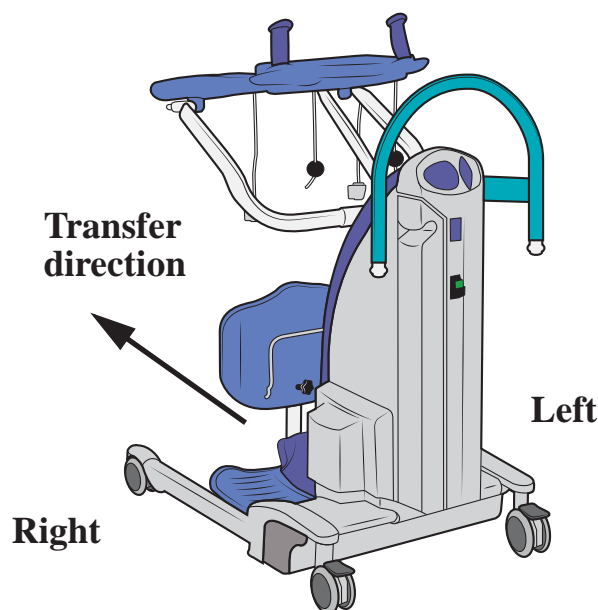
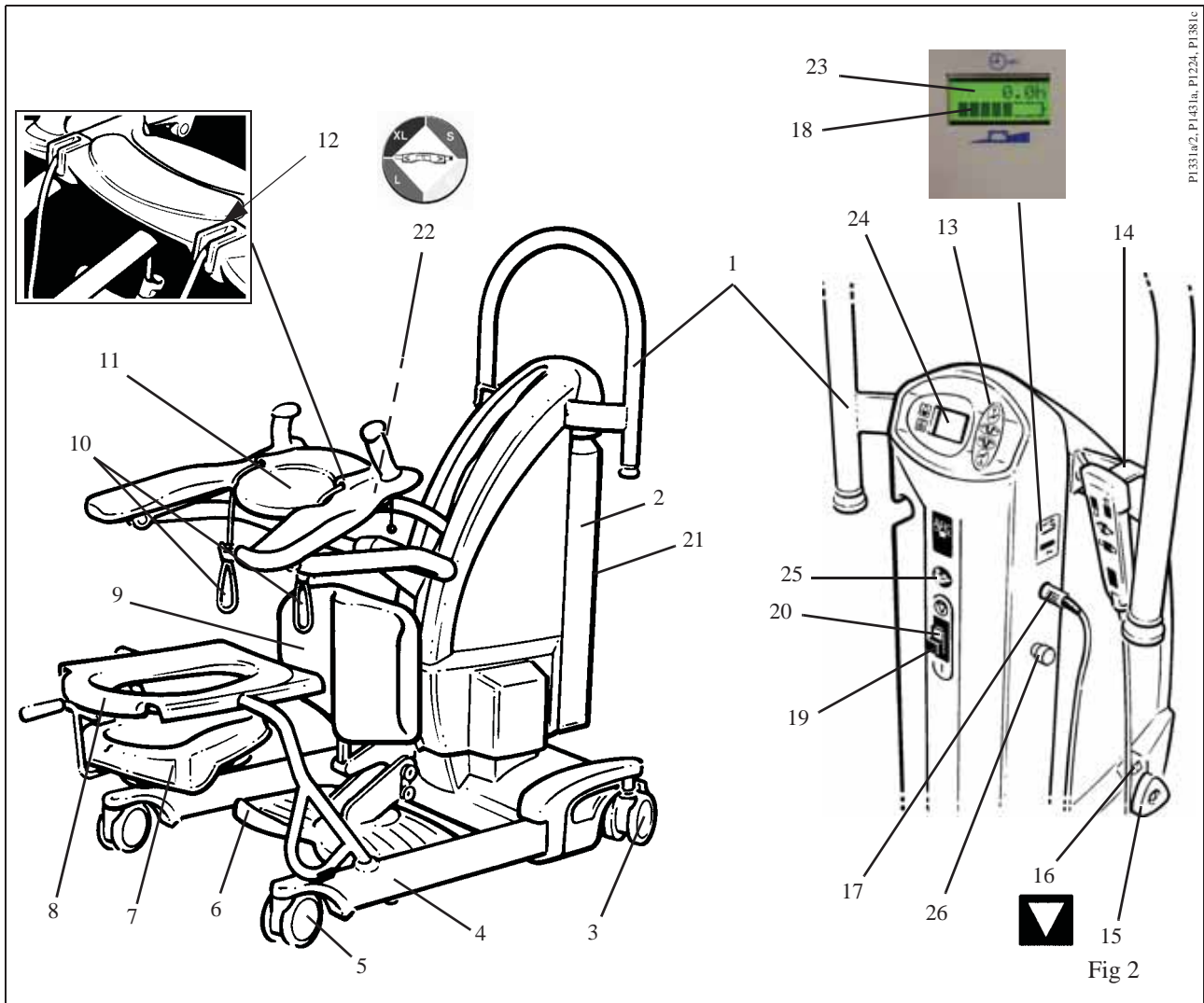

Fig 1

# Parts designation



P1331a2, P1431a, P1224, P1381c

- |   |  |
|---|--|
| 1. Maneuvering handle                               | 14. Hand control   |
| 2. Battery pack                                     | 15. System failure lower override knob                   |
| 3. Braked castors (rear)                            | 16. Label - System failure lower override identification |
| 4. Chassis legs                                     | 17. Handset cable connection                             |
| 5. Front castors (unbraked)                         | 18. Battery discharge indicator                          |
| 6. Foot support (removable)                         | 19. Power on/reset button (green)                        |
| 7. Commode pan (optional)                           | 20. Power off button (red)                               |
| 8. Commode seat and frame (optional)                | 21. Label - Read <i>IFU</i> before use                   |
| 9. Proactive Pad™ (adjustable)                      | 22. Label - Sling size guide                             |
| 10. Attachment cords (for sling)                    | 23. Hour/cycle meter                                     |
| 11. Arc-Rest™ (supportive arm rests with handgrips) | 24. Scale display panel (if available)                   |
| 12. Detail view of cord locking cleats              | 25. Label - Read <i>IFU</i> before use                   |
| 13. Dual control panel                              | 26. Emergency stop button                                |



# Product description

## Controls and features

**Hand control:-** The hand control is attached to the lift by an extending cable. The handset controls lift and lower and chassis leg opening/closing. Direction arrows adjacent to the buttons indicate each function. (See Fig 3)

If pressure is released from any button during use, powered movement stops immediately.

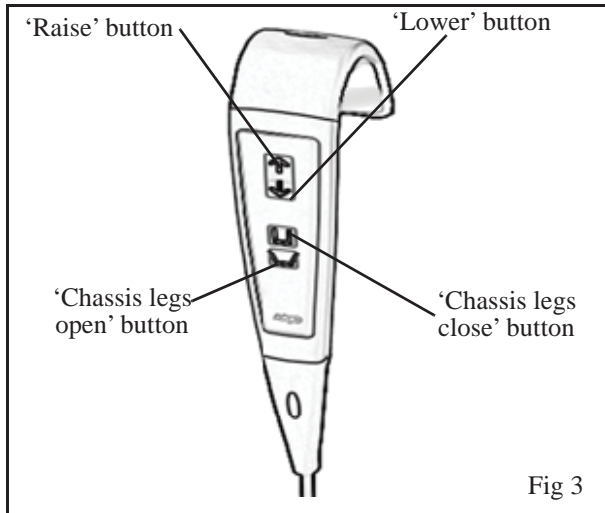

Fig 3

**Dual control panel:-** offers the same controls as the handset and is positioned on the top of the main body of the lift. (See Fig 4)

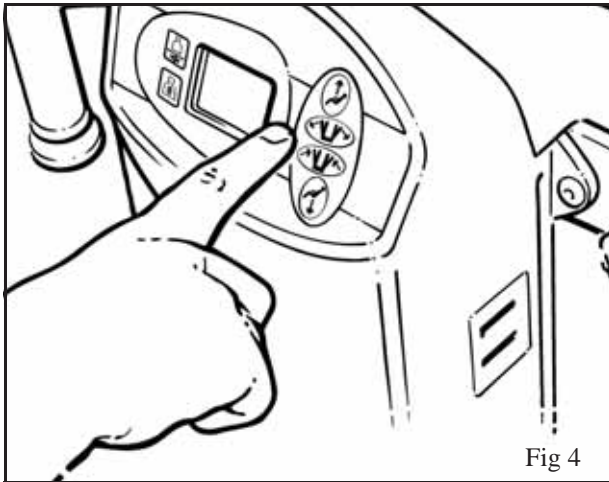

Fig 4

**Emergency stop button (red):-** If, in an emergency, you have to immediately stop any powered movement, (other than by releasing pressure on the button either on the handset or dual control panel), press the emergency stop button situated on the side of the cover.

Once the emergency stop button has been operated, it must be reset by turning the red cap until it pops back out, before any further powered movement can be utilised.

**Power on/reset button (green):-** On the rear of the case below the dual control panel. Press this button to turn on power to the lift. Also used to reset if the automatic overload fuse has operated (indicated by the button projecting outwards slightly). If the fuse has operated and once reset, operates again, withdraw the lift from use and contact Arjo Service department or their appointed distributor.

**Power off button (red):-** On the rear of the case below the dual control panel. Press this button to turn off power to the lift.

**Automatic cut out:-** (not an operator control but a function built into the lift electronics).

If the *Sara Plus* is inadvertently overloaded (trying to lift a patient heavier than permitted), an automatic 'cut out' operates to prevent the lift raising a load in excess of the safe working load; this stops the lift motion automatically. 'overload' occurs on the Hour/Cycle meter and the buzzer beeps continuously when any button is pressed.

If this occurs, when pressure is released from the lift button on the handset or dual control the electronics is reset. 'overload' disappears from the Hour/Cycle meter. The patient can now be lowered, by pressing either lower button. Remove the patient from the lift.

**Automatic stop function:-** Great care should be taken not to lower the Arc-Rest onto the patient or any other obstruction but if this should happen inadvertently the motor continues to run but the downward movement is held by the obstruction. If this occurs release pressure from the 'lower' button immediately, operate the 'raise' button until clear, then remove the obstruction.

**OverHeat protection:-** Buzzer beeps twice with interval 15 seconds and 'OverHeat' is displayed on the Hour/cycle meter when operator exceeds duty cycle for mast actuator (2min/18min), movement is still possible. The function protects the actuator from damage.

**System failure lower override:-** This can be used in the event of main control failure. In the unlikely event that the hand control or dual control panel fails to operate the lift, with a patient still supported by the sling, provision for lowering has been made, using the "lower override knob", situated on the right hand side of the main cover. A label situated above the switch. (See Fig 5)

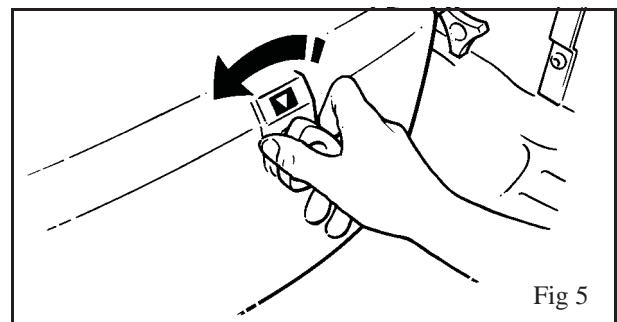

Fig 5

# Product description

## Use the System failure lower override (2 steps)



**Warning:** Before operating the lower override to lower a patient, always make sure that a chair or suitable support is underneath ready to accept the patient.

1. To operate the lower override, turn the knob anti clockwise half a turn. (See Fig. 5)
2. To cease lowering turn the knob clockwise until finger tight only (do not over tighten).

Only use this knob in the event of normal control failure. Do not use it for normal function lowering.

The lower override will operate whether the emergency stop button has been operated or not. The “automatic stop function” of the jib will still operate when using the lower override knob.

When using the *Sara Plus* normally, always make sure the system failure lower override knob is always turned fully clockwise and finger tight.

**Battery discharge indicator:-** There is a small battery symbol on the bottom of the LCD. The battery symbol shows the level of battery charge.

**Hour/cycle meter:-** The upper line of the display shows the total duration of lifting and lowering operation in hours. The display can also show the number of cycles by pressing the raise and lowering buttons at the same time. This is intended as an aid to help calculating the service intervals.

**Chassis castor Brakes:-** The chassis rear castors have brakes which can be foot operated if required for example, when leaving the patient unattended, or to keep the *Sara Plus* in position. (See Fig 6)

**Straight line steering function :-** When using the *Sara Plus* for walking practice it may be considered useful to fix one of the castors to steer in a straight line. This has the effect of allowing the *Sara Plus*, without caregiver assistance to follow the intended straight line walked by the patient. The function is activated by flipping over the steering guide on the rear castor to hold it in position. (See Fig 6)

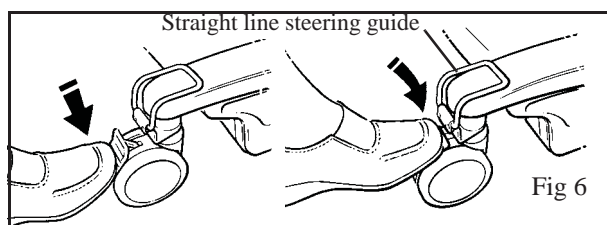

**Arc-Rest (with handgrips):-** Integral Part of the Lifting mechanism of the lift, the intuitive and supportive armrests allow patient participation and comfort during the lifting procedure.

**Foot support:-** For positioning the patient’s feet when lifting and transporting. The Foot Support can be removed if using the *Sara Plus* to lift a patient to their feet prior to them using a walking aid.

## Remove the Foot support (8 steps)

1. Raise the Proactive Pad to its highest position.

**Note:** *If installed, unclip one side of the hook and loop tie strap from around the foot support cover and slide the cover up the knee support column.*

2. Position yourself between the chassis legs and grip both sides of the foot support.
3. Lift up the front half of the foot support until it just comes into contact with the foot support bracket.
4. Pivot the rear of the foot support upwards until the foot support is horizontal.
5. Pull the foot support towards yourself until it is clear of the support bracket. (See Fig 7)
6. Store carefully for future use.
7. Slide the foot support cover back down into position and secure using the hook and loop strap.
8. Re-adjust the Proactive Pad to the position required.

Re-fit the foot support by reversing the procedure.

**Note:** *Make sure the two hooks on the foot support are located over the top two locating buttons.*

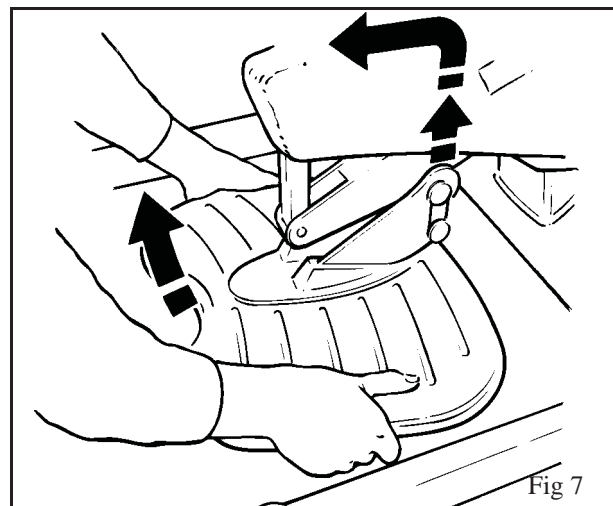

# Product description

**Proactive Pad:-** This is a reactive lower leg support which enables the patient to be lifted comfortably and effortlessly. It can be adjusted vertically for differing lower leg lengths and is sprung to stay in contact, when the patient's legs move radially during the lifting procedure.

## Adjust the Proactive Pad (2 steps)

1. Hold the Proactive Pad with one hand and slacken the clamping screw knob with the other hand.
2. When the correct height has been established re-tighten the knob. (See Fig 8)

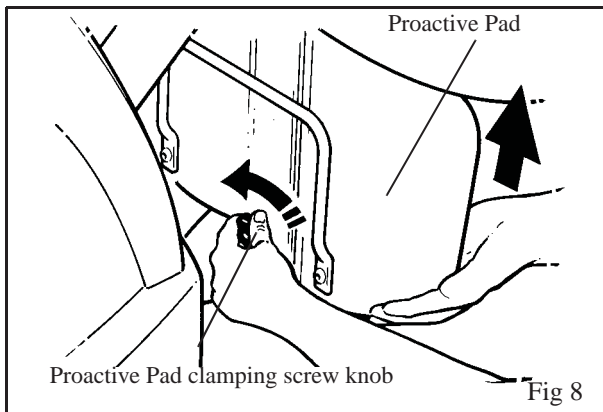

It can be removed from its mount quickly, for walking practice, simply by lifting upwards, after the foot support has been removed.

**Lower leg straps (accessory):-** An accessory used for ensuring the lower parts of the patient's legs stay in close proximity to the Proactive Pad for correct lifting procedure. The strap is held in position in relationship to the Proactive Pad.

## Attach the Lower leg straps (4 steps)

1. Pass the Lower leg straps through the guides on the back of the Proactive Pad.
2. Put the Lower leg straps around one or both of the patients lower calves.
3. Overlap and press the Lower leg straps together to join the hook and loop strap fastening. (See Fig 9)
4. Make sure the Lower leg straps is firm but comfortable for the patient.

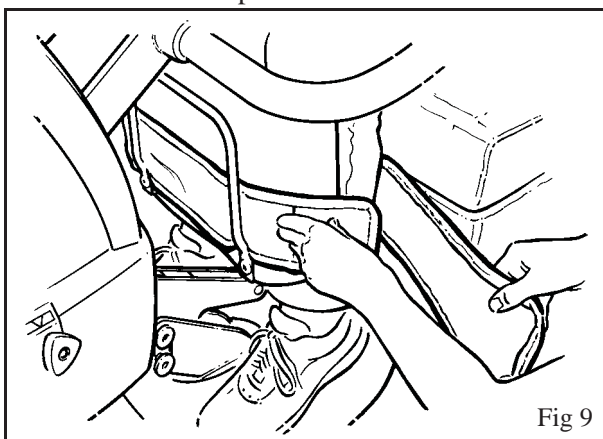

**Adjustable width chassis legs:-** By operating the appropriate button on either the hand control or dual control panel on the lift the chassis legs can be opened to any variable width. (See Fig 10)

When pressure is released from the button, movement stops and the chassis legs remains securely in position.

**Note:** Transportation should be done with the chassis legs closed, it will be easier through doorways etc

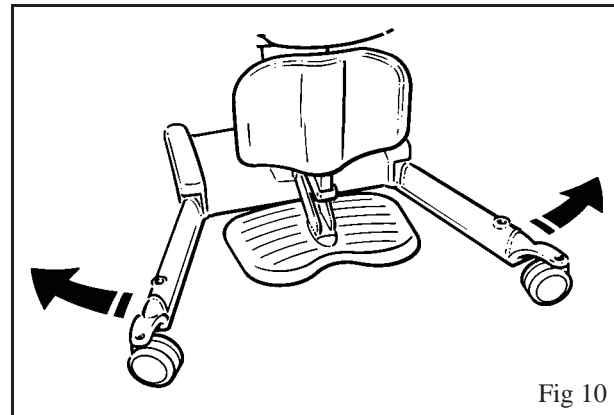

**Warning:** At all times the patient and/or operator should not allow their feet or any other part of their body to be placed in the area between the foot support and chassis legs when the chassis legs are closing.

**Scale (if available):-** If your *Sara Plus* has been supplied with the integral Scale unit, it is possible to weigh a patient during the lifting procedure.

## Allowed slings with Sara Plus

Two types of sling can be used with the *Sara Plus*.

**Standing Sling** – a single loop, used for supporting patients at the toilet, and to aid in the standing process. The sling may have a 'fleece' cover for added comfort, which can be easily removed for cleaning.

- KKA5090 Standing sling
- KKA5120 Standing sling
- KKA5370 EPS/BOS Standing sling
- KKA6000 Arjo Wipeable Standing C-Hook sling
- MFA4000 *Flites*

**Transfer and Walking Sling** – A loop sling with back, buttock and leg support, used for easy and comfortable transporting of patients over short distances without the need for the detachable seat frame. By using different attachment straps the same sling can be used for supporting patients during the training procedure of standing, stepping and walking under the supervision of trained nursing staff. The sling has variable adjustment.

- KKA5130M Transfer/Walking sling

# Product description

---

## *Commode seat (optional)*

For toileting patients at the chair or bedside or for patients who cannot be transported with the transfer sling, the use of the commode seat and frame is the recommended method of transporting patients over longer distances. The commode frame is inserted into the holes in the chassis legs once the patient has been lifted to a standing or near standing position in the manner previously described. (See Fig 11)

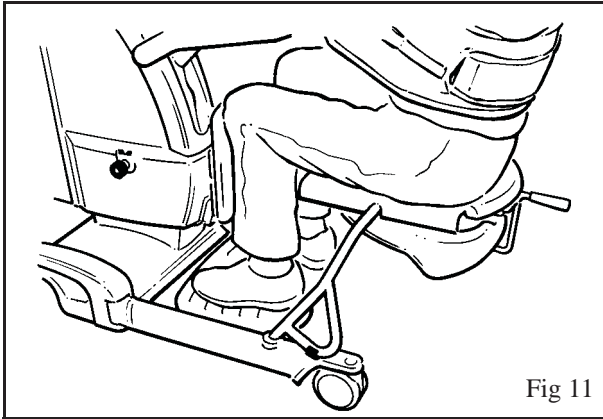

Removal of any clothing can be attended to, and the patient is then lowered down onto the commode seat. It is recommended that the patient is kept supported by the sling.

The retractable commode pan, accessible from the rear of the seat, may be utilised, or removed to enable the patient to be positioned over a toilet. Apply chassis brakes if leaving the patient unattended. (See Fig 12)

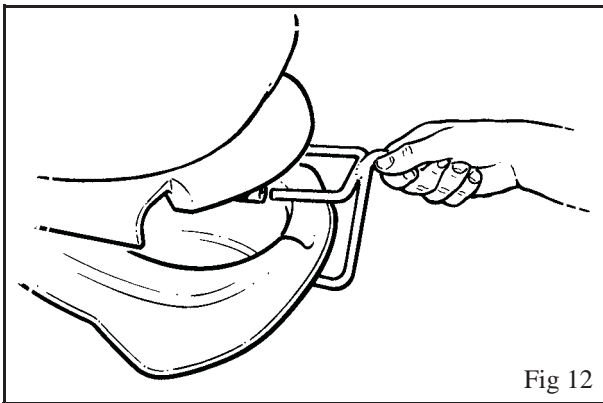

# How to use the Sara Plus

## General

All references to the patient in these instructions refer to the person being lifted, and reference to the caregiver refer to the person who operates the lift.

Lifting operations in these instructions are described as if lifting a patient from a chair, the same operations can be performed effectively when lifting a patient from a wheelchair or sitting position on a bed, although a second caregiver should support the patient if the patient lacks sitting balance.

All operations in these instructions are described as if the caregiver were using the hand control. Each operation described can be controlled using the hand control and/or the dual switch panel, situated at the rear of the mast.

Before every procedure starts, the caregiver should always:

- inform the patient what they are going to do
- have the correct size and type of sling ready. (See description of sling types in the “Allowed Slings with Sara Plus” section.)
- have the *Sara Plus* nearby

## Prepare Sara Plus and patient (7 steps)

1.  **Warning:** The support belt must always be applied when using any of the slings.

Select and apply the sling according to respective sling *IFU*.

2. Adjust the height of the lift Arc-Rest to be raised or lowered sufficiently to avoid approaching the patient at eye level and making allowances for the patients arms and any obstructions, e.g. chair arms etc.

**Note:** *If the handset button or dual control button is released during lifting or lowering powered motion stops immediately.*

3. Approach the patient from the front with the lift, stop before the foot support and Proactive Pad are in contact with the patient. (See Fig 13)

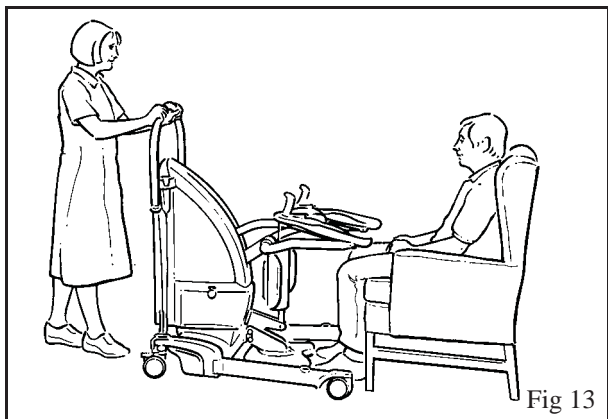

**Note:** *If required, the chassis legs may be opened to go around the chair, by operating the appropriate button on the hand control or dual control on the lift.*

4. **For transfers:** When the patient is ready, give assistance or allow the patient to place his/her feet on the foot support, pushing the *Sara Plus* towards the patient a little to achieve this easily. (See Fig 14).

**For walking:** Remove the foot support from the lift and store carefully for future use (see section “Product Description”).

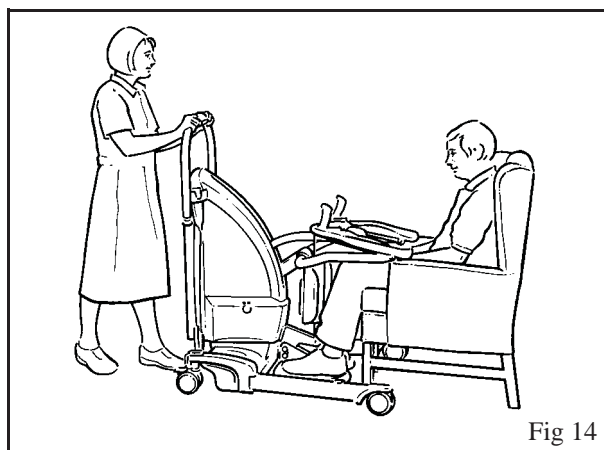

5.  **Warning:** Make sure the cord end knobs are away from the Proactive Pad when the patients legs are near or in contact with the pad.

Adjust the Proactive Pad height (if necessary). Align the top of the Proactive Pad just below the patient’s patella or higher based on patient comfort. (See Fig 15).

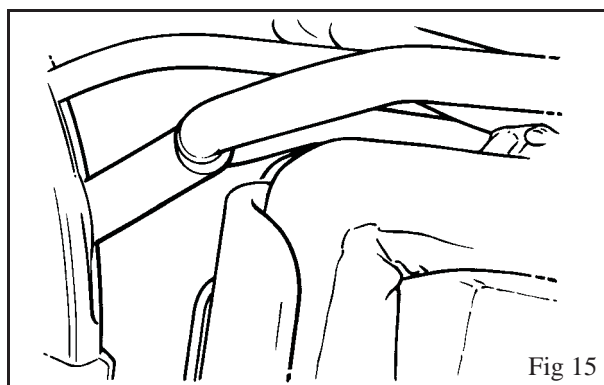

# How to use the Sara Plus

6. Carefully push the lift closer to make full lower leg contact with the Proactive Pad. (See Fig 16)

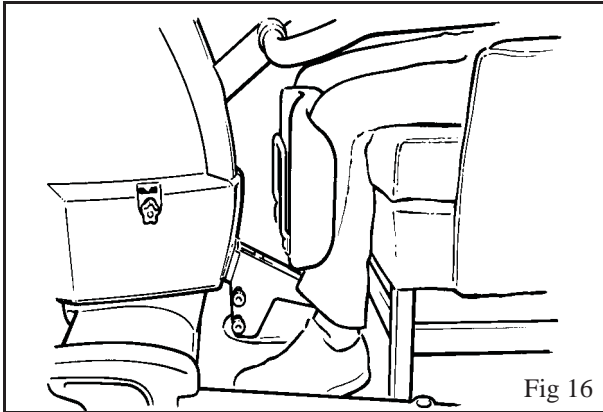

7. Apply the chassis brakes.

## Use the Standing sling for transfer (14 Steps)



**Warning:** Assessment have to be made whether the patient requires the lower leg straps, apply if necessary.

- 1.



**Warning:** Make sure the cone is pulled tightly into the cup section. (See Fig 17)

Take each attachment cord in turn and attach to the sling. (See Fig 17)

Fitting the Loop Lock cord attachment system

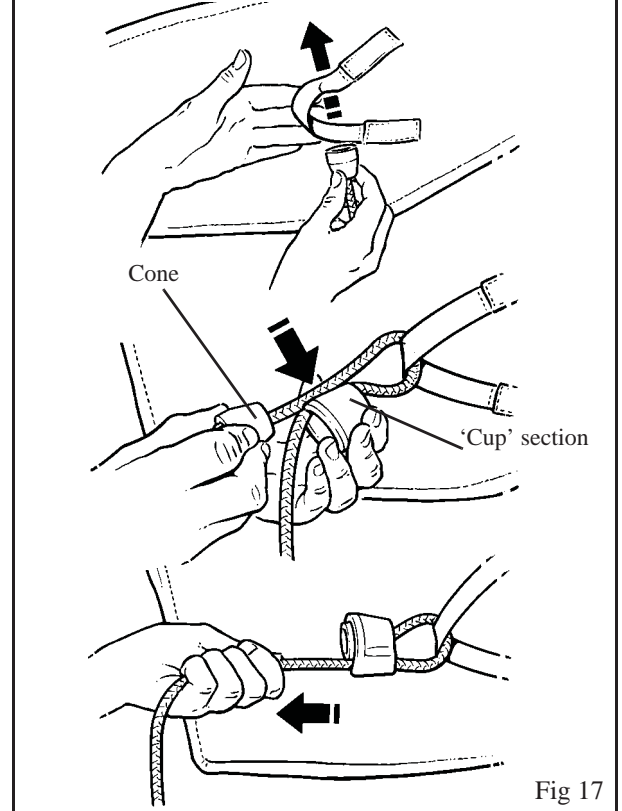

2. When both cords are attached correctly, make adjustments on both cords equally so that any slack is taken up in each cord and the back section of the sling supports the patient comfortably and securely.

# How to use the Sara Plus

3. Lock the attachment cords down into the cord retaining cleats. (See Fig 18)

**Note:** *The patient should be supported by the sling, but not pulled forward too much. (See Fig 18)*

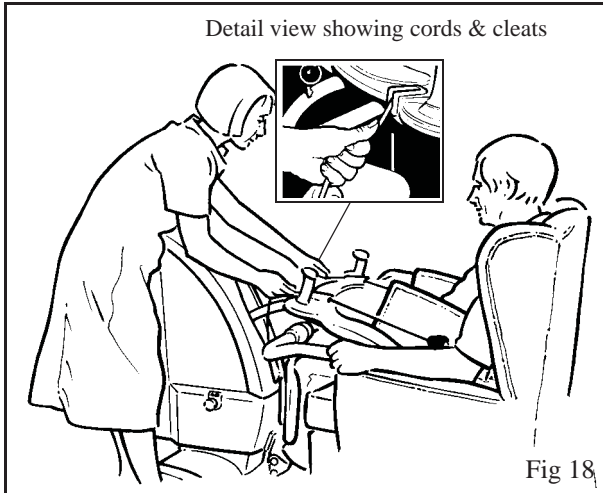

4. If possible, the patient should hold on to the Arc-Rest with one or both hands. (See Fig 19)

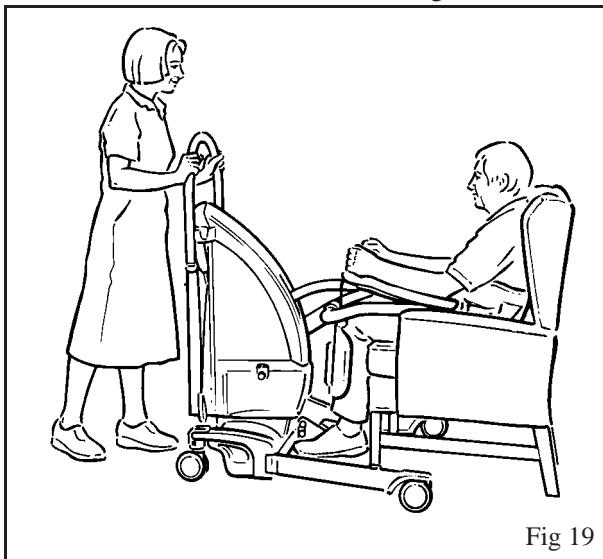

**Note:** *If the patient can only hold on with one hand, (those who have suffered a "stroke", for example) the patient may still be lifted by using the Sara Plus. The patient may just rest the unusable arm on the Arc-Rest or hold it across their chest, and rest their elbow on the end of the Arc-Rest, while their usable hand holds the handgrip in the normal way.*

5. If the patient is able to offer some assistance when standing this may be beneficial to patient confidence and muscular exercise. Encourage the patient to assist all he/she can to raise from the chair and/or steady themselves.

- 6.



**Warning:** Make sure the attachment cords and the clips on the attachment strap are fully in position and locked before and during the commencement of the lifting cycle, and in tension as the patients weight is gradually taken up.

Check that the attachment cords and the clips on the attachment strap are fully in position and locked before and during the commencement of the lifting cycle, and in tension as the patients weight is gradually taken up.

7. Operate the lift button on the handset or dual control panel to raise the patient to a suitable and comfortable height for the particular function, e.g. transportation, toileting with commode, etc. (See Fig 20)

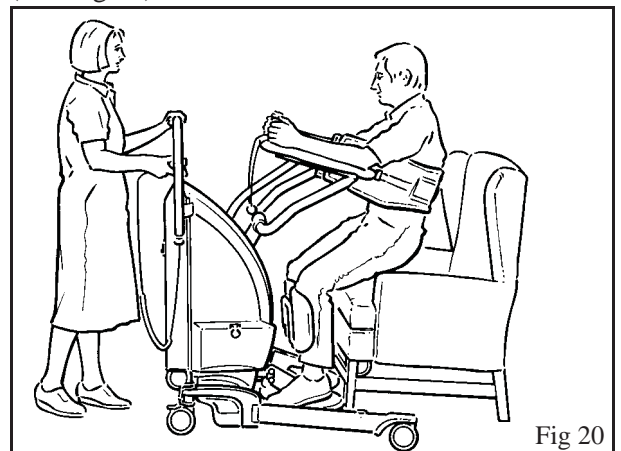

**Note:** *If the patient can stand sufficiently well and lock his/her knees in the normal way when fully raised, their knees are away from the Proactive Pad and he/she is able to lean back into the sling.*

- 8.



**Warning:** Only use this or other methods after a satisfactory professional assessment has been carried out on the individual patient.

If required insert the detachable seat frame into the receptor holes in the chassis legs, then lower the patient to a comfortable seating position for commode toileting or longer distance transportation. (See Fig 21)

**Note:** *To fit the seat frame, the chassis legs must be adjusted to the closed position.*

# How to use the Sara Plus

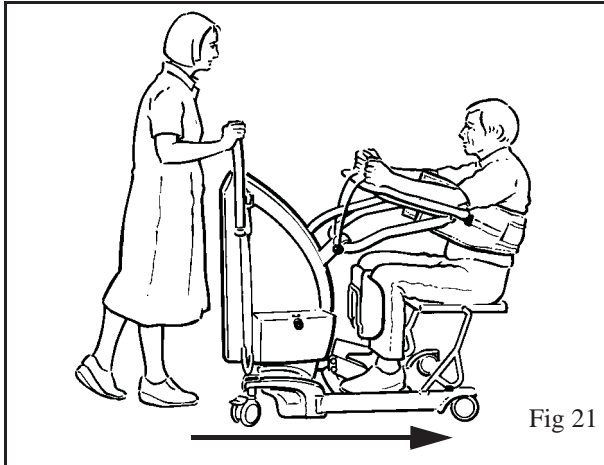



Fig 21

9. Release the brakes and transfer the patient to new position, i.e., toilet, wheelchair, chair, bed, etc.

**Note:** Transportation should be done with the chassis legs closed, it is easier through doorways etc. Always move in the direction shown in Fig. 21.

10. While the patient is raised, make any necessary adjustments to clothing, incontinence pads etc., before lowering again.

11.  **Warning:** Apply the chassis brakes if leaving the patient at the toilet, or if leaving the patient unattended.

Lower the patient carefully using the hand control or dual control panel.

12.  **Warning:** Do not attempt to release the support belt while the patient is supported by the sling.

When the patient is seated in the new position, detach the sling from the patient:

1. Pull each cord up from the locking cleats and slacken the cords sufficiently to release the Loop Lock fitting, then remove the cords from the sling.
2. Pull apart the hook and loop strap fastening or unfasten the buckle to remove the support belt.

13.  **Warning:** If the patient lacks sitting balance and has been returned to sit on the side of the bed, a second caregiver may be needed to support the patient while the sling is being removed.

Remove the sling from the patient.

14. Remove the lower leg straps if they have been applied.

## Use the Transfer/Walking sling for transfer (16 steps)

(140 kg - 308 lb maximum patient weight)

1. Identify the attachment strap on each leg section of the sling and attach the right hand attachment cord to the left strap, repeat for the other side. (See Fig 22 and Fig. 17 for attachment of the cords)

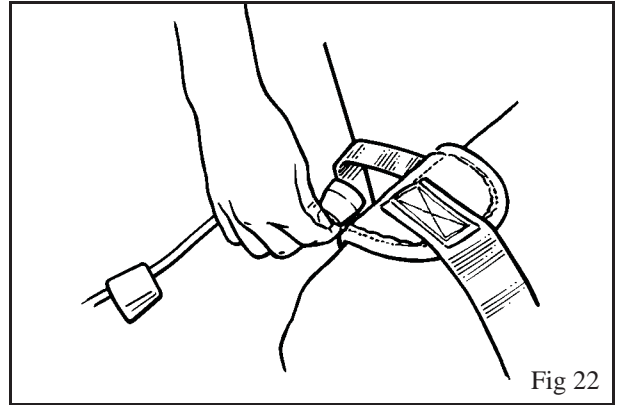



Fig 22

2. When both cords are attached correctly, make adjustments on both cords equally so that any slack in the cord is taken up.

3.  **Warning:** Lock the attachment cords down into the cord retaining cleats.

Make sure the attachment cords are locked down into the cord retaining cleats. (See Fig 23)

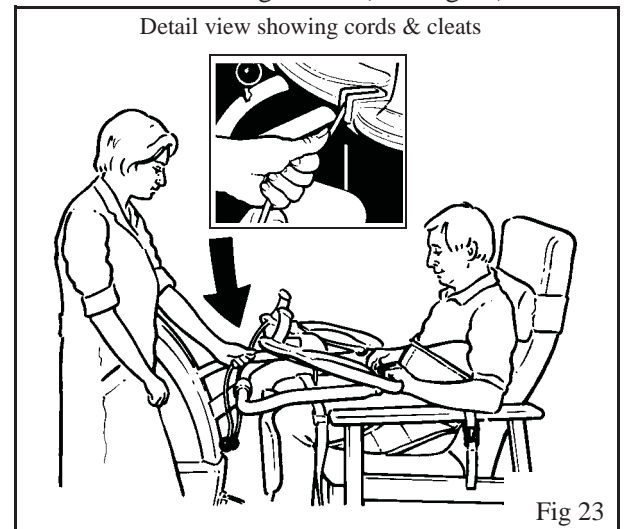



Fig 23

4. Identify the attachment strap on each side of the sling support belt (fitted with a plastic attachment clip), and adjust both straps to their maximum length.



# How to use the Sara Plus

5.  **Warning:** Attach each clip correctly and secure onto the lug.

Make sure each clip is attached to the lug situated on the outer sides of the Arc-Rest. (See Fig 24)

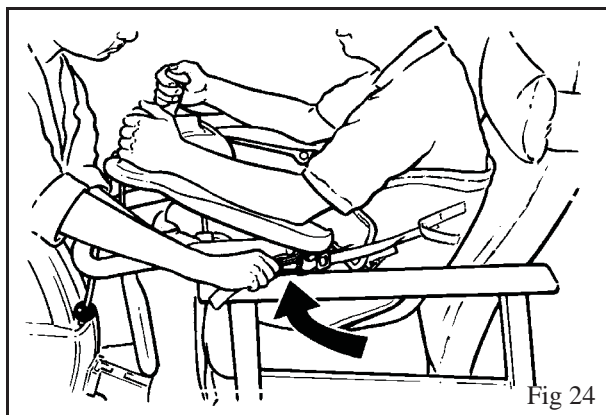

Fig 24

6. Allow the patient to hold the hand grips with their arms resting on the Arc-Rest.
7. Operate the lift button on the handset or dual control panel, continue to raise until each attachment strap is in tension and the patient's back just comes away from the chair, then stop the lift. (See Fig 25)

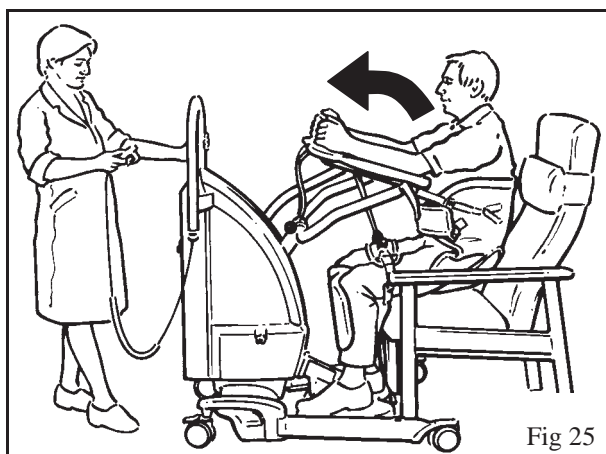



Fig 25

8. Adjust both cords equally to take up any slack, lock both cords into the locking cleats.
9. Continue raising until the patient is just clear of the seat. If any discomfort is experienced by the patient return to the sitting position and re-adjust.

10.  **Warning:** Make sure the attachment cords and the clips on the attachment strap are fully in position and locked before and during the commencement of the lifting cycle, and in tension as the patients weight is gradually taken up.

Check that the attachment cords and the clips on the attachment strap are fully in position and locked before and during the commencement of the lifting cycle, and in tension as the patients weight is gradually taken up.

11. Do not to raise the patient too high as this will negate the comfort of the transfer sling.
12. Release the chassis brakes and close the chassis legs, then transport the patient to desired position. (See Fig 26)

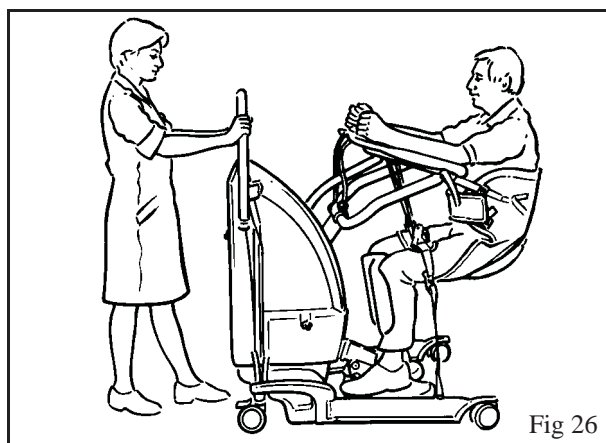



Fig 26

**Note:** *Transportation should be done with the chassis legs closed, it is easier through doorways etc.*

13.  **Warning:** Apply the chassis brakes if leaving the patient unattended.

Lower the patient carefully using the hand control or dual control panel.

14.  **Warning:** Do not attempt to release the straps or cords while the patient is supported by the sling.

When the patient is seated in the new position, detach the sling from the patient:

1. Pull each cord up from the locking cleats and slacken the cords sufficiently to release the Loop Lock fitting, then remove the cords from the sling.
2. Pull apart the hook and loop strap fastening or unfasten the buckle to remove the support belt.

15. Remove the sling from the patient.
16. Remove the lower leg straps if they have been applied.

# How to use the Sara Plus

## Use the Transfer/Walking sling for walking (12 steps)

(190 kg - 420 lb maximum patient weight)

1. Identify the attachment straps on each side of the sling body and attach the cords (Loop Lock method as previously shown in Fig. 17).  
When both cords are attached correctly adjust both cords equally so that the slack is taken up, but does not pull the patient forward.

2.  **Warning:** Lock the attachment cords down into the cord retaining cleats. (See Fig 17)

Make sure the attachment cords are locked down into the cord retaining cleats. (See Fig 27)

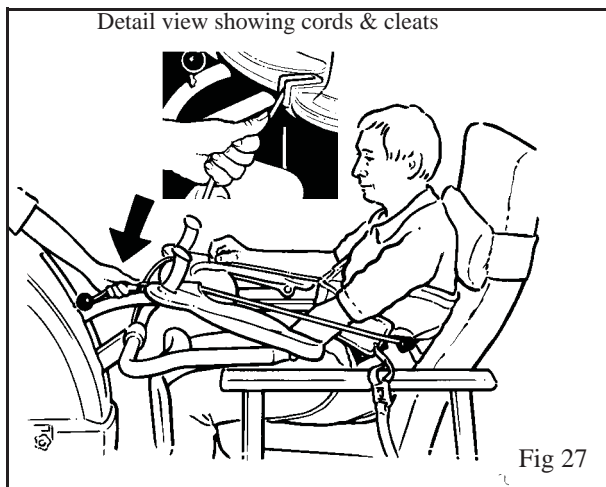

3. Allow the patient to hold the handgrips with their arms resting on the Arc-Rest.
4. Slacken the adjustment on each body attachment strap (if required), enough to be able to connect the attachment clips to the lugs on the outer sides of the Arc-Rest. (See Fig 28)

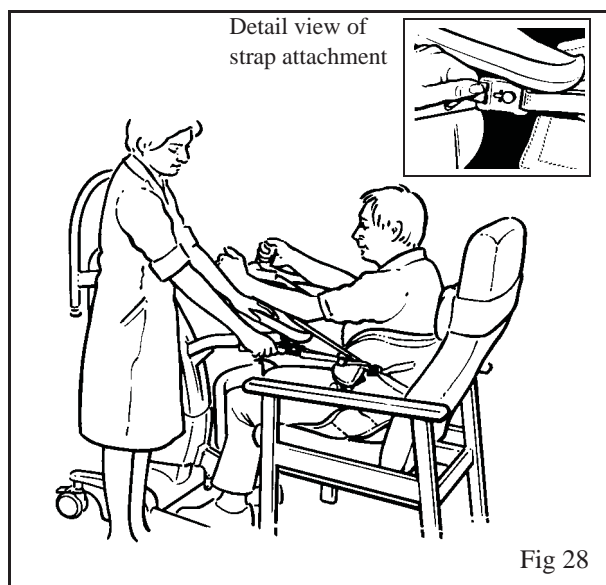

5. When the patient is ready, operate the lift button on the handset or dual control to raise the patient, at the same time encourage him/her to actively stand. (See Fig 29)

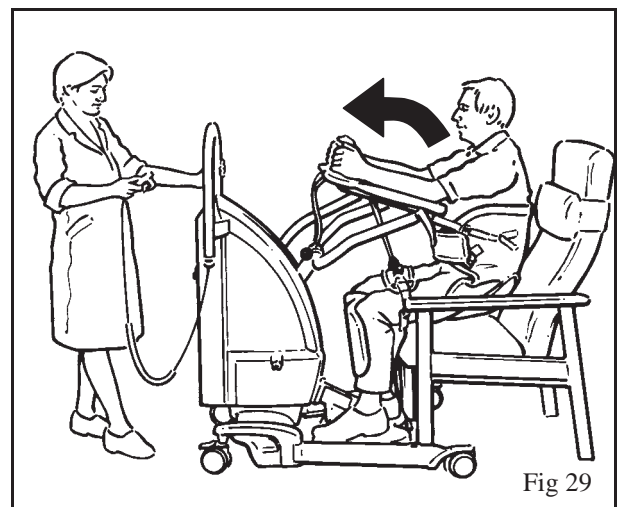

6. Continue to raise the Arc-Rest until the patient is in a comfortably supported standing position. (See Fig 30)

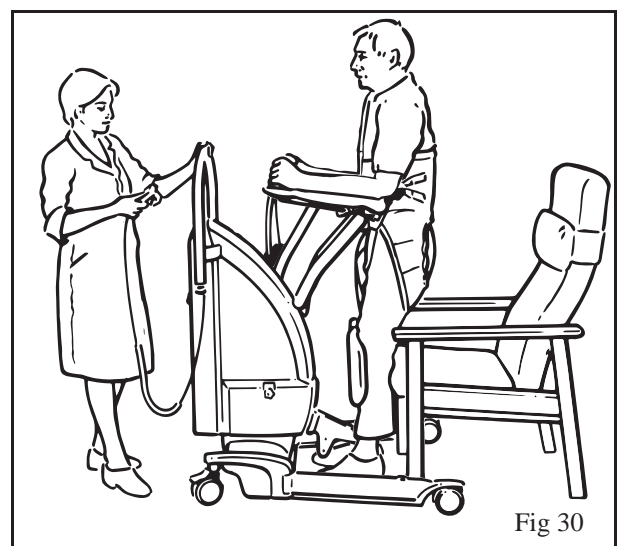

7. If walking practice is to be carried out make sure the patient is correctly and comfortably supported, adjust the body attachment straps equally to take up any slack and be supportive but not too tight and make adjustment to the Arc-Rest as necessary.

# How to use the Sara Plus

8. When the patient is standing confidently release the brakes and pull the lift slightly away from the patient until the Proactive Pad is clear of the patients legs. (See Fig 31)

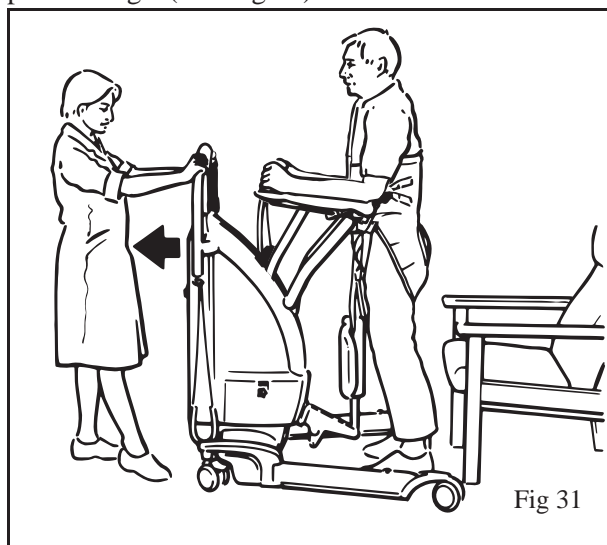

Fig 31

9. **Warning:** When the Proactive Pad assembly is removed, make sure that the attachment bracket is also removed before starting therapy. Failure to do so could lead to serious injury.

Re-apply the chassis brakes then carefully remove the Proactive Pad complete with attachment bracket by lifting upwards and store carefully for future use. (See Fig 32)

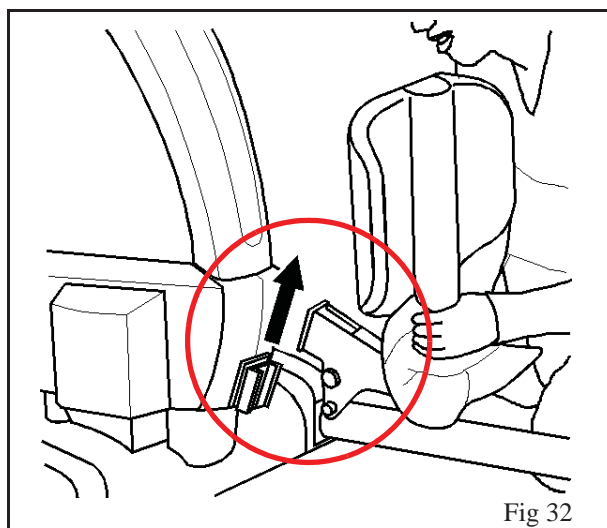

Fig 32

**Note:** The chassis legs may be opened or left open to give better clearance for the patient.

**Note:** The 'straight line' steering lock (if fitted) can be applied over the rear castor as an additional aid if required.

10. With the Proactive Pad removed and the brakes released, the patient is able to walk at their own pace, while being supported by the Sara Plus. (See Fig 33)

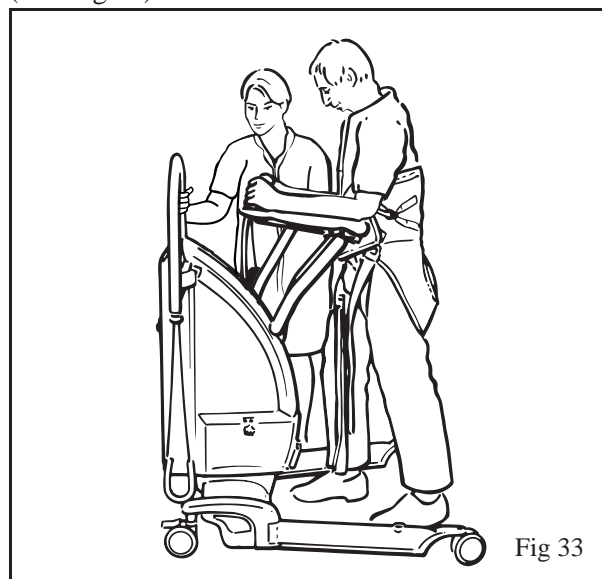

Fig 33

**Note:** To have better flexion for the leg it may be necessary to slacken the leg straps slightly, this allows better leg movement.

11. **Warning:** Do not unfasten or release the attachment cords at any stage other than when the patient is seated and fully supported. Make sure there are no obstructions in the path before the patient is encouraged to walk.

**Warning:** When refitting the Proactive Pad, make sure the pad is reinserted, re-tightened, and covers the support bracket. Failure to do so could lead to serious injury.

Once walking practice has been completed:

1. Apply the chassis brakes.
2. Replace the Proactive Pad.
3. Return the patient to a chair.

12. When the patient is fully supported, remove the sling by reversing the fitting procedure.

*Arjo scale (if available)*

To use the scale, if available, refer to the *Scale IFU*.

# Battery Instructions



**Warning:** The charging of the battery must only be performed away from the patient environment.

The charger is for indoor use only.

Only use the charger unit in a dry environment, do not use it in the bathroom.

Do not expose the charger unit or battery pack to rain or spray and do not immerse in water.

Do not expose the charger unit to dust.

To avoid overheating, the charger must not be covered whilst in use.

No smoking or naked flames in battery vicinity.

The battery charger is for use only with Arjo supplied batteries that are to be used with the *Sara Plus*.

The battery charger is for use with sealed lead acid batteries only.

Under no circumstances should the charger be used to attempt to charge non-rechargeable batteries.

Do not attempt to open or tamper with the charger unit in any way, for any repair the charger must be sent to the manufacturer.

The mains electricity socket must be easily accessible. Should a faulty condition occur switch off and remove the connection plug from the socket.

Only use Arjo components that have been specifically designed for the purpose when charging batteries

Only use the Arjo battery that is supplied to be used with the *Sara Plus*.

Only use the Arjo charger unit supplied with the *Sara Plus*.

Do **NOT** place batteries near, or dispose of, in a fire.

Do **NOT** short circuit a battery.

Do **NOT** store batteries at temperatures in excess of 60°C (140°F).

A battery that is charged for the first time, or after a long storage period, must be charged until the charger indicates full charge.



**Warning:** Do **NOT** crush, puncture, open, dismantle or otherwise mechanically interfere with batteries.

Should the battery casing become cracked, and electrolyte come into contact with skin or clothing, wash immediately with water.

If the electrolyte contacts the eyes, wash immediately with copious amounts of water, and seek medical attention.

When disposing of batteries, contact the appropriate local authority for advice.

The abbreviation “Pb” shown adjacent to the recycling and trash bin symbols on the battery back label is the element symbol for lead, and indicates that the battery contains lead and therefore should not be disposed of in the normal manner but must be recycled.

**Note:** *Make sure the battery is removed from the lift if it is anticipated it will not be used for a prolonged period of time.*

## Battery discharge indicator

The *Sara Plus* incorporates a Battery discharge indicator, situated on the right hand side of the cover. (See Fig 2 on page 7 in section “Parts Designation”)

The display shows eight levels of battery state ranging from fully charged on the right to very low on the left (filled segment to empty segment).

**Note:** *The battery discharge indicator has an energy saving function, automatically switching off the display if a function button has not been operated for at least 60 seconds. The moment a button is pressed to operate any function, the display will re-start.*

It is recommended that the battery is removed from the lift and charged when the display reaches the 3 filled segments and the buzzer beeps once every 10 seconds. Lifting is possible until the display shows one filled segment and the buzzer beeps continuously. At this point, the battery must be charged as soon as possible.

# Battery instructions

Recharging the battery pack before it reaches a low state of battery charge or certainly totally discharged will prolong its life.

To make sure the *Sara Plus* is always ready for use, it is recommended that a freshly charged battery pack is always available. This is achieved by having additional battery packs available and keeping one on charge while the other is in use.

It may be considered good protocol to have a freshly charged battery ready for the start of every work shift.

The battery life is variable (2-5 years) and mainly depends on proper charging practices. To extend the battery life, the battery must be charged at regular intervals until the charger indicates full charge. This can be done overnight.

## Charge the battery (9 steps)

When the battery discharge indicator displays 3 filled segments complete your lift cycle and remove the battery pack.

1.  **Warning:** Hold the pack firmly to make sure it does not drop and become damaged, or cause personal injury.

Hold the grip of the battery and press the release catch above. Turn the battery away and lift clear.

2. Take the battery to the battery charger unit and make sure the battery is positioned securely.
3. Insert the battery connector from the charger into the corresponding connector in the back of the battery.

**Note:** *The cable that connects the main electricity supply to the charger is supplied as a detachable item. If using the battery charger for the first time or if the cable has been unplugged from the charger, connect the cable fully into the charger before connecting to the mains electrical socket.*

4.  **Warning:** Always make sure the cable connection plugs that fit into the charger and into the battery are fully inserted before switching on mains electricity.

Switch on main power.

An orange light is displayed on the charger unit when the battery is totally discharged.

This will change to a yellow light as the battery approaches full charge capacity, finally changing to a green light when the battery is fully charged.

5. Charge the battery until the charger indicates full charge.

**Note:** *The battery pack may be left connected to the charger unit when it is fully charged without being damaged by overcharging, this will also make sure the battery is kept fully charged.*

6. When the battery pack is fully charged, disconnect the main power.
7. Remove the battery pack from the charger.
8. Insert it into the *Sara Plus* battery position, located at the left hand side of the lift:
9. Locate the recess in the bottom of the battery with the protrusion at the bottom of the battery position then turn the battery into position until the retaining catch operates.  
Electrical connection is made automatically.



**Caution:** Turn off the hoist after use by pressing the red Power off button. This reduces the power consumption.

# Cleaning and disinfection

## General Lift Care

How often the following actions are taken depends on how often the equipment is used, please refer to the “Preventive maintenance schedule” in the “Care and preventive maintenance” section.

Unless otherwise stated, begin once a week and then rely on experience to decide how often it is necessary in the future.

 **Warning:** It is recommended that Arjo Patient lifts, equipment, accessories and slings are regularly cleaned. If the slings, lifts and equipment needs cleaning, or are suspected of being contaminated, follow the cleaning and/or disinfection procedures recommended below, before re-using the equipment. This is especially important when using the same equipment for another patient, to minimise the risk of cross infection.

 **Warning:** Cleaning and disinfection products must be used in accordance with the manufacturers instructions and suitable eye, hand and clothing protection must be worn at all times when handling disinfectants.

## Cleaning

For cleaning your lift, equipment and accessories wipe down with a damp cloth using warm water to which a mild detergent has been added. Take extra care with areas that may trap dust or dirt.

 **Warning:** The lift should be cleaned before it is used by another patient.

 **Caution:** Do not over wet areas of the product which could cause problems with electrical components or internal corrosion.

If a hot air dryer is used to dry the lift, the temperature must not exceed 80°C (176°F).

Do not use petroleum based solvents or similar, since this may damage plastic parts.

## Disinfection

To disinfect the device, clean the equipment first, then wipe it using a solution containing one of the compatible disinfectants below:

DISINFECTANTS	Sara Plus
Alcohol isopropyl ≤ 70%	X <sup>1,2</sup>
Chlorine ≤ 1% (10,000 ppm)	X <sup>1</sup>
Hydrogen peroxide ≤ 1.5%	X <sup>1,2</sup>
Peracetic acid ≤ 0.25% (2,500 ppm)	X <sup>1</sup>
Phenolic ≤ 1.56% (15,600 ppm)	X <sup>2</sup>
Quaternary ammonium ≤ 0.28% (2,800 ppm)	X

<sup>1</sup>Bare metal parts may discolor after repeated contact with alcohol isopropyl, chlorine, hydrogen peroxide and peracetic acid.

<sup>2</sup>Switch panel may discolor after repeated contact with alcohol isopropyl, hydrogen peroxide and phenols.

 **Caution:** Do not use any disinfectant on any electrical connector.

Disinfection methods should comply with the local or national guidelines (Decontamination of Medical Devices), depending on the Healthcare Facility or country of use. If uncertain, consult local Infection Control specialist.

**Note:** *A rubbing action is necessary when using wipes to promote effective disinfection of the surfaces.*

**Note:** *Check that the lift can be propelled in a normal manner, making sure that the castors roll and swivel freely. Clean with water. (the function can be affected by soap, hair, dust and chemicals from floor cleaning).*

# Cleaning and disinfection

## *Cleaning and Disinfecting the Toilet Commode Chair and Frame (if fitted)*

For exterior areas of the seat and frame the “hard surface disinfectant wipes” mentioned above will be very effective, but for internal and crevice areas of the equipment Arjo recommend that the seat and frame is cleaned in accordance with your normal cleaning and disinfecting protocol.

### *Remove the Commode seat (2 steps)*

1. Pull the rear edge up sharply to disengage the locating lugs.
2. Slide the seat forwards a short distance until clear of the frame tubes and lift away. (See Fig 34)

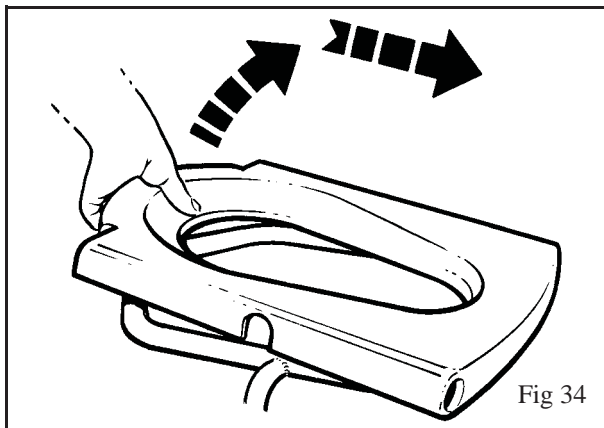

### *Cleaning and disinfecting the cords (2 steps)*

1. For cleaning the attachment cords and the loop and lock assembly, wipe down with a damp cloth using warm water to which a mild detergent has been added

**Note:** *If soil is visible on the attachment cords after cleaning, the cords must be changed by a qualified service technician.*

2. Disinfect the cords and the loop and lock assembly by wiping them with a solution containing one of the compatible disinfectant (see table DISINFECTANTS on page 20.)

### *Attach the Commode seat (3 steps)*

1. Locate the seat holes over the seat frame tubes.
2. Align the location lugs over the rear cross bar of the seat frame. (See Fig. 35)

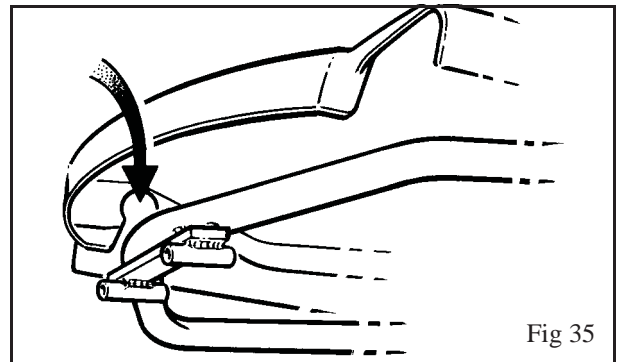

3.  **Warning:** Always make sure the seat is secure before allowing a patient to use it.

Apply sharp downward blows onto the rear of the seat, in two places directly above the location lugs, until the seat ‘snaps’ back into place. (See Fig. 36)

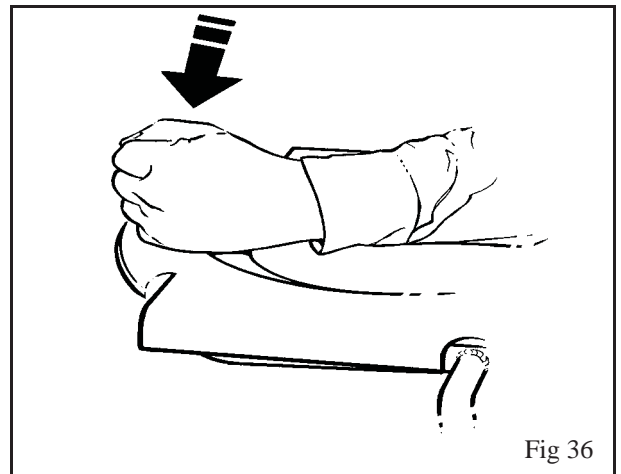

# Care and preventive maintenance

The *Sara Plus* is subject to wear and tear, and the following actions must be performed when specified to ensure that the product remains within its original manufacturing specification.



**Warning:** The points on this checklist are the minimum the manufacturer recommends. In some cases due to heavy use of the product and exposure to aggressive environment, more frequent inspections shall be carried out. Continuing to use this product without conducting regular inspections or when a fault is found will seriously compromise the user and residents' safety. Local regulations and standards may be higher than the manufacturers. Preventive maintenance specified in this manual can prevent accidents.

**Note:** *Product cannot be maintained and serviced while in use with the patient.*

## Preventive maintenance schedule

Action/Check	Between patients	Before each use	Every week	Every 12 months
<b>CAREGIVER OBLIGATIONS</b>				
Cleaning/Disinfection	<b>X</b>			
Examine the sling, straps and clips for damage or fraying as required. Refer to sling documentation.		<b>X</b>		<b>S</b>
Visually check exposed surfaces for damage, sharp edges, etc.			<b>X</b>	
Visually check sling attachment points. Do not use if damaged.			<b>X</b>	
Make sure all labels are attached.			<b>X</b>	
Check to make sure the hand grips are secure. Re-bond if required.		<b>X</b>		<b>S</b>
Examine the charger and wires for integrity and connections.				<b>S</b>
Operate the <i>Sara Plus</i> through its full range.			<b>X</b>	
Visually check the handset and cable for damage.			<b>X</b>	
Perform a full function test on the <i>Sara Plus</i> .			<b>X</b>	<b>S</b>
Check operation of the Stop/Reset and System Lower Override Device.			<b>X</b>	<b>S</b>
Check batteries for leakage and/or deterioration. Replace if required.			<b>X</b>	<b>S</b>
Make sure all fixings, screws, nuts are secure and tight.			<b>X</b>	<b>S</b>
Check and clean all castors. Replace as required.			<b>X</b>	<b>S</b>
Check that the covers fit correctly and are not damaged. Replace as required.			<b>X</b>	<b>S</b>
Check for evidence of corrosion. Replace as necessary.			<b>X</b>	<b>S</b>



**Warning:** The actions marked with 'S' must be carried out by qualified personnel, using correct tools and knowledge of procedures referring to the Service Manual. Failure to meet these requirements could result in personal injuries and/or unsafe product.



**Warning:** Unauthorized modifications or repairs to the *Sara Plus* may affect its safety and will invalidate any warranty. Arjo accepts no liability for any incident, accident or reduction in performance that may occur as a result of such repairs or modifications.

To maintain the safety of this equipment, always use only Arjo designated spare parts.



# Care and Preventive Maintenance

## *Before every use*

Make sure the battery is charged before use. If not adequately charged, replace with a fully charged battery. Where necessary, after each patient use, carry out decontamination of the *Sara Plus* in accordance with this IFU, and local regulations.

## *Daily*

Make sure the battery pack is in a good state of charge. Charge the battery at the end of each working shift, or as soon as possible if the Battery Discharge Indicator displays this and gives a audible warning. See *Battery charging* in this IFU.

Make sure the Lower Override knob is turned fully clockwise and is finger tight (do not over tighten).

Make sure that the sling attachment cords and the loop lock assembly are visually inspected before and after each use. Any component found frayed or damaged, or visibly contaminated or soiled, must be replaced.

## *Weekly*

For longevity regularly charge battery/s until the charger indicates full charge. See section "*Battery instructions*".

## *General lift condition*

A general visual inspection of all external parts should be carried out, and all functions should be tested for correct operation, to make sure that no adverse damage has occurred during use.

- Make sure all castors rotate freely and the two rear brakes lock. Where installed, make sure the Straight Line Steering Guide locks the rear castor in line.
- Make sure the castor-mounting pin is tight on the chassis and chassis legs and the castor tread is not damaged
- Open and close the chassis legs and check for full travel and smooth movement.
- Examine the condition of the handset and its cable. Replace if damaged.
- Make sure all external fittings are secure, and all screws and nuts are tight.
- Make sure the handgrips are secure, tighten if required.
- Examine the integrity of the loop lock assemblies and the knot within the cone knob.
- Make sure the screw retaining the front clevis pin in the upper lift arm is tightened.
- Make sure the screws retaining the cord cleats in the Arc-Rest are tight.
- Make sure all instruction labels are firmly attached and are readable.
- Examine all exposed parts, especially where there is personal contact with the patient's body. Make sure no cracks or sharp edges have developed that could cause patient or caregiver injury or have become unhygienic. Replace where necessary.

- Make sure the foot support can be removed and replaced and there is no damage to the hook and location pins on the Foot Bracket assembly.

## *Automatic stop function*

With the Arc-Rest raised well above its lowest position, lower it, and at the same time hold the Arc-Rest up briefly. The motor continues to run while the Arc-Rest weight is held. This check is for the correct function of the automatic stop.

## *Emergency stop*

Test the emergency stop by operating the Arc-Rest. Press in the emergency stop button. (See Fig 2 on page 7 in section "Parts Designation") The movement should stop immediately.



**Warning:** If in any doubt about the correct functioning of the *Sara Plus*, withdraw it from use and contact Arjo Service Department.

## *Servicing advice*



**Warning:** Arjo recommend that the *Sara Plus* is maintained at regular intervals, see Preventative maintenance schedule in this document.



**Warning:** UK LIFTS ONLY: Important legislation came into force on 5th December 1998, which has an impact on the schedule of service for your patient lift(s), variable height baths and other raising and lowering equipment. The Lifting Operations and Lifting Equipment Regulations (LOLER) 1998 and The Provision and Use of Work Equipment Regulations (PUWER 98) must be satisfied by the duty holder. A scheme of six monthly thorough examinations has been devised to comply with the law and details can be obtained from Arjo Service UK

Parts lists and circuit diagrams are available from Arjo or their approved distributors.

Spare parts, if required are available from Arjo or their approved distributors.

Special tools are required for certain component replacement.

# Troubleshooting

Problem description	Probable cause	Solution
The <i>Sara Plus</i> is new and not functioning at all.	Power off button (red) is still engaged.	Press the green Reset/power on button to disengage the Power off button.
The <i>Sara Plus</i> is raising and lowering more slowly than usual.	Low battery power level.	Check the Battery discharge indicator (on the mast of the <i>Sara Plus</i> , just above the battery). This indicates the power level of the battery. If in doubt, replace the battery with a fully charged one and compare the performance. In case of low battery power level, replace the battery on the <i>Sara Plus</i> with a fully charged one.
The <i>Sara Plus</i> does not raise or lower and the chassis legs cannot be opened or closed when using the hand control.	Hand control is damaged	Try operating the <i>Sara Plus</i> with the Dual up/down control located on the mast. If the equipment functions correctly when using these controls, the hand control should be replaced.
The <i>Sara Plus</i> does not raise or lower and the chassis legs cannot be opened or closed when using either the hand control or the Dual up/down controls.	Control electronics or actuator malfunction	Contact your Arjo representative or an Arjo approved service engineer.
When the “Raise” button is pressed, the <i>Sara Plus</i> makes a noise, “overload” is displayed on the Hour/cycle meter and buzzer beeps continuously but the resident support arms do not move upwards.	The resident support arms are blocked by an obstruction	Remove the obstruction and check the <i>Sara Plus</i> thoroughly for damage before continuing the lifting cycle. If in doubt, use the System failure lower override to return the resident to a safe seated position, then remove the <i>Sara Plus</i> from use. Do not use the equipment again until it has been inspected and passed for safe working by an Arjo approved service engineer.
When the “Chassis legs open” button is pressed, the <i>Sara Plus</i> makes a noise., “overload” is displayed on the Hour/cycle Meter and the buzzer beeps continuously but the chassis legs do not open.	The chassis legs are blocked by an obstruction.	Remove the obstruction and check the <i>Sara Plus</i> thoroughly for damage before continuing the lifting cycle. If in doubt, use the System failure lower override to return the resident to a safe seated position, then remove the <i>Sara Plus</i> from use. Do not use the equipment again until it has been inspected and passed for safe working by an Arjo approved service engineer.
Unexpected movement of hoist	Faulty hand control, push buttons or electronics.	If releasing the buttons does not work: Push the red Emergency stop button and remove the battery from the hoist. Use the System failure lowering override to put the patient back into a safe seated position, then remove the <i>Sara Plus</i> from use. Do not use the equipment again until it has been inspected and passed for safe working by an Arjo approved service engineer.
“OverHeat” is displayed and the buzzer beeps twice every 15 seconds.	The actuator duty cycle is exceeded (2 minutes ON/ 18 minutes OFF).	Finish the operation and wait 18 minutes. This prevents the actuator from damage.

# Technical specification

## Patient weights



All slings - check the safe working load on the sling label

	kg	lb
Safe Working Load	190	420
Maximum weight limit to be lifted or carried (when using the Standing sling)	190	420
Maximum weight limit to be lifted or carried (when using the Transfer/Walking sling for walking practice only)	190	420
Maximum weight limit to be lifted or carried (when using the Transfer/Walking sling for transfer operation only)	140	308
Maximum weight limit to be carried (when using the Toilet commode seat and frame)	190	420

## Component weights

	kg	lb
Sara Plus - non-scale version (complete - without battery)	73.8	162.7
Sara Plus - scale version (complete - without battery)	82.9	182.8
Sara Plus - scale version (complete - with scale and battery)	88	194
Maximum total weight of lift (lift + patient)	278	614
Battery pack	4.9	10.8
Commode seat and frame (option)	4	8.8
Commode pan and holder (option)	1.2	2.6
Foot support	5	11

## Electrical

Battery type and part number	(Rechargeable - lead acid): SPL3021
Battery capacity:	6 Ah
Battery charger part number: (Note:** indicates relevant country code)	SPL3024**
Fuse	15 A (Thermal overcurrent circuit breaker)
Fuse – PCBA	20 A
Fuse – battery	30 A
Protection class lift	IP 24
Protection class hand control	IP X7
Lift nominal voltage:	24 V DC
Operating force of controls	< 5 N
<p>Medical Equipment:- type BF  protection against electrical shock in accordance with IEC 60601-1            Arjo patient handling products meet the requirements of Electromagnetic Compatibility (EMC) as stated in clause 12.5 of the Medical Devices Directive 93/42/EEC</p> <p> Although compliant with EMC requirements there is a remote chance that close proximity usage may affect over-sensitive electrical equipment</p> <p>The symbol IP n<sub>1</sub>n<sub>2</sub> indicates the degree of ingress protection against solid particles (n<sub>1</sub>) and liquids (n<sub>2</sub>).            2: Protection against solid particle ingress larger than 12.5 mm - fingers or similar objects.            4: Protection against liquid ingress - water splashing against the enclose from any direction shall have no harmful effect.</p> <p>Conforms to IEC 60601-1:2012(ed.3.1), ANSI/AAMI ES60601-1:2005 / A2:2010, CAN/CSA-C22.2 No. 60601-1:08 and ISO 10535:2006.</p>	

# Technical specification

---

## Electrical

	Duty cycle	Max volts	Max amps
Mast Lift Actuator (sealed electro-hydraulic unit)	10% (2 min/18 min)	24 V	20 A
'V' Chassis Actuator (electro-mechanical unit)	10% (2 min/18 min)	24 V	8 A

## Maximum sound power level

In accordance with ISO 3746 (dB re 1pW ± 3dB)	74 dB
--	-------

## Environment

Operating, transport and storage	
Temperature	+10 °C to +40 °C (+50 °F to +104 °F) Operation -20 °C to +70 °C (-4 °F to +158 °F) Transport -20 °C to +70 °C (-4 °F to 158 °F) Storage
Relative humidity range	30% to 75% Operation 10% to 80% including condensation Transport and Storage
Atmospheric pressure	800 hPa to 1060 hPa Operating 500 hPa to 1100 hPa Transport 500 hPa to 1100 hPa Storage

## End of Life Disposal

- All batteries in the product must be recycled separately. Batteries are to be disposed in accordance with national or local regulations.
- Lift systems having electrical and electronic components or an electrical cord should be disassembled and recycled per Waste of Electrical and Electronic Equipment (WEEE) or in accordance with local or national regulation.
- Components that are primarily be made up of different kinds of metal (containing more than 90% metal by weight) for example sling bars, rails, upright supports, etc., should be recycled as metals.

# Dimensions

## Sara Plus dimensions

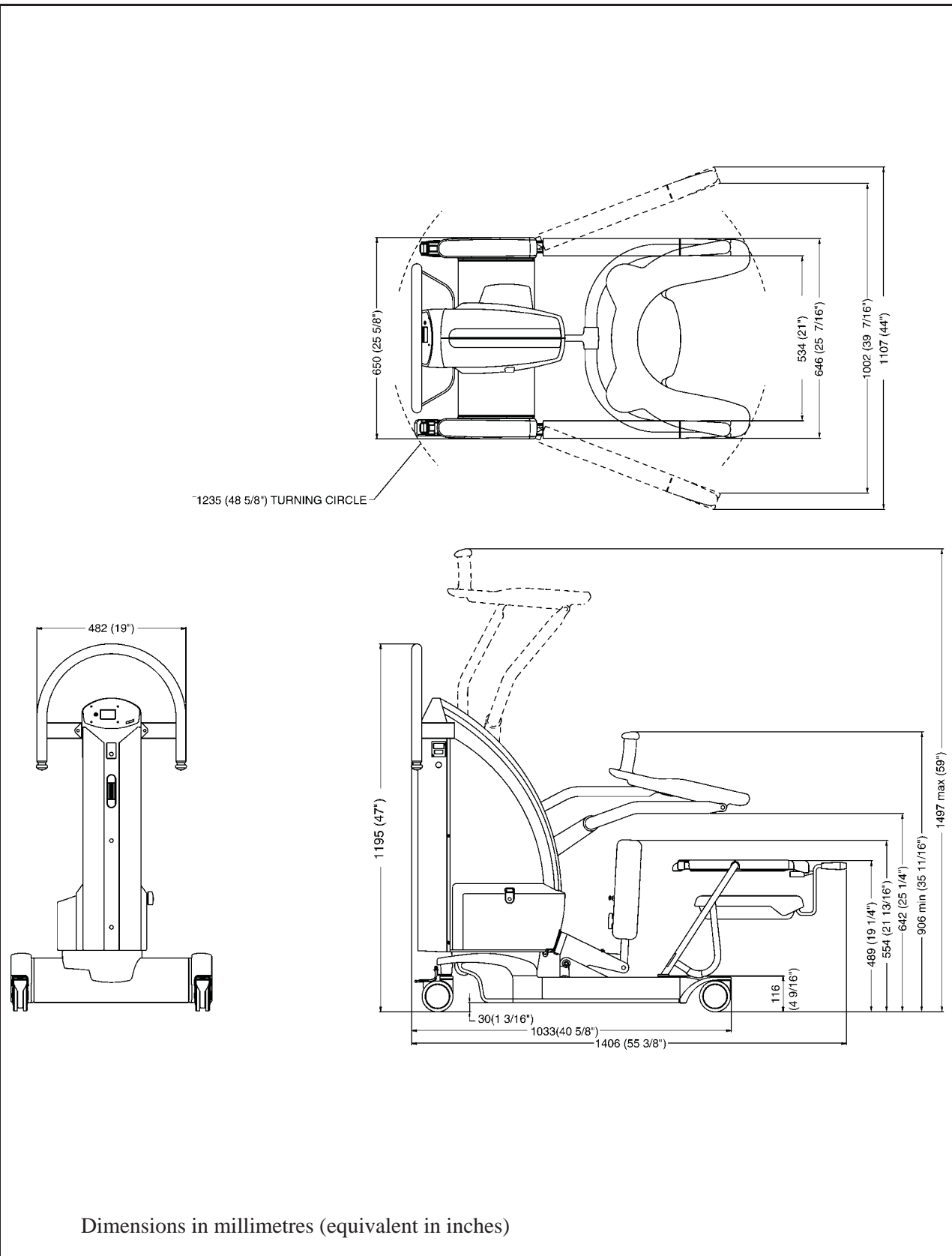



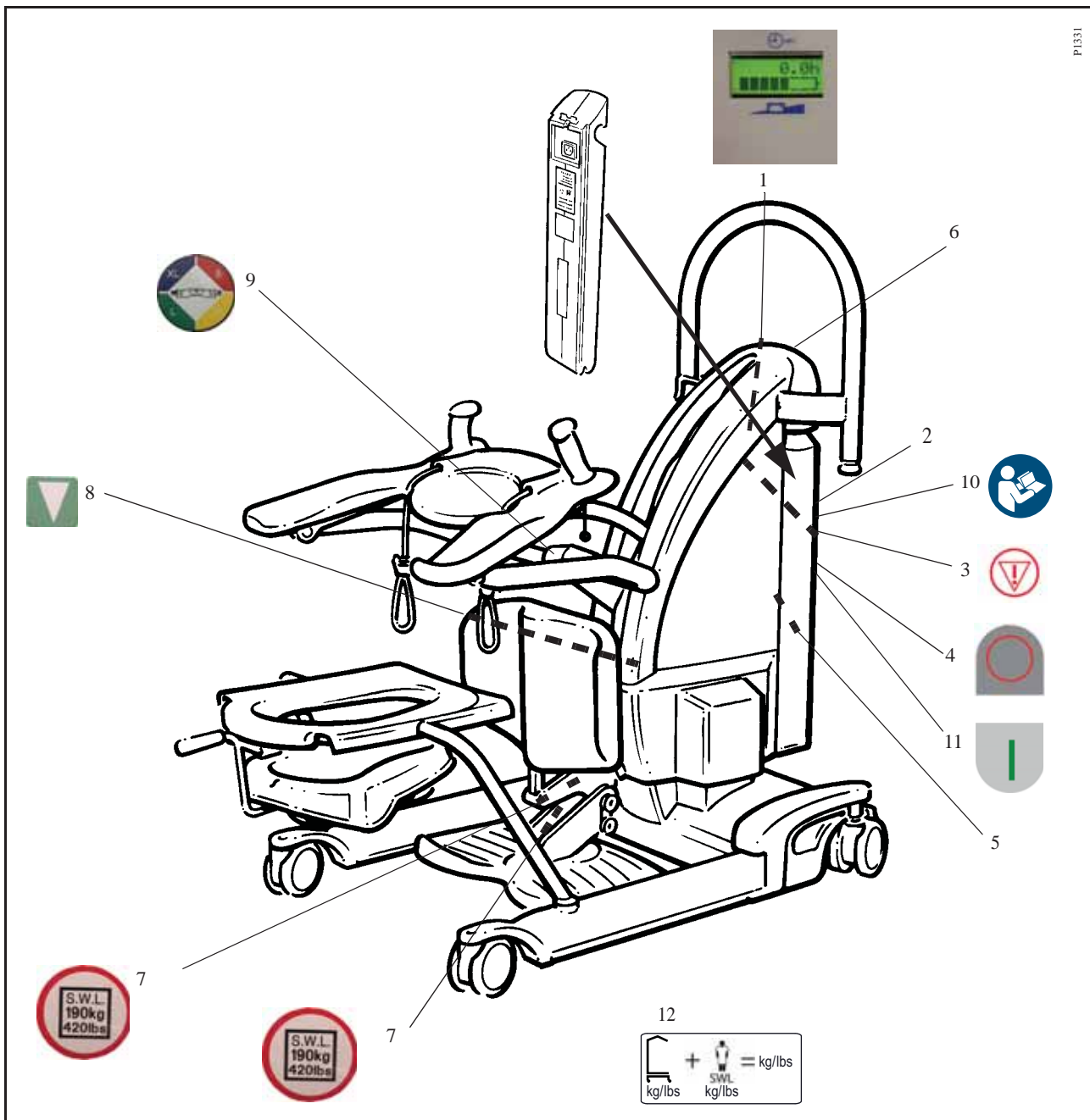





# Labels on the Sara Plus

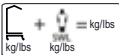

- |  |  |
|--|--|
| 1. Battery discharge indicator and Cycle/ Hour meter | 9. Sling size guide                        |
| 2. Arjo logo   | 10. Read operating instructions before use |
| 3. Emergency stop button identification              | 11. Power On/Reset button identification   |
| 4. Power Off Button identification                   | 12. Maximum total weight of lift           |
| 5. Address and SWL 190 kg (420 lbs)                  |  |
| 6. Product name                                      |  |
| 7. Safe working load 190 kg (420 lbs)                |  |
| 8. System failure lower override identification      |  |

# Labels on the Sara Plus

Symbol explanation	
	Mandatory to read the Instructions for use
	A battery is the power source of this equipment.
	Separate electrical and electronic components for recycling in accordance with the European Directive 2012/19/EU (WEEE)
	Recyclable
IP 24	Degree of protection (i.e. the product is protected against insertion of fingers and splashing water
	Type BF Applied part: protection against electrical shock in accordance with EN/IEC 60601-1.
	CE marking indicating conformity with European Community harmonised legislation Figures indicate Notified Body supervision.
	Indicates the product is a Medical Device according to EU Medical Device Regulation 2017/745
	Total mass of equipment including its safe working load.
	Name and address of the manufacturer
	Manufacturing date

# Electromagnetic Compatibility

Product has been tested for compliance with current regulatory standards regarding its capacity to block EMI (electromagnetic interference) from external sources.

Some procedures can help reduce electromagnetic interferences:

- Use only Arjo cables and spare parts to avoid increased emissions or decreased immunity which can compromise the correct functioning of the equipment.
- Make sure that other devices in patient-monitoring and/or life-support areas comply to accepted emissions standards.



**Warning:** Wireless communications equipment such as wireless computer network devices, mobile phones, cordless telephones and their base stations, walkie-talkies, etc. can affect this equipment and should be kept at least 1.5 m away from the equipment.

Intended Environment: Home Healthcare Environment and Professional Healthcare facility environment.

Exceptions: HF Surgical Equipment and the RF Shielded room of an ME SYSTEM for magnetic resonance imaging.



**Warning:** Use of this equipment adjacent to or stacked with other equipment should be avoided because it could result in improper operation. If such use is necessary, this equipment and the other equipment should be observed to verify that they are operating normally.

Guidance and manufacturer's declaration – electromagnetic emission		
Emission test	Compliance	Guidance
RF emissions CISPR 11	Group 1	This equipment uses RF energy only for its internal functions. Therefore its RF emissions are very low and are not likely to cause any interference in nearby electronic equipment.
RF emissions CISPR 11	Class B	This equipment is suitable for use in all establishments, including domestic establishments and those directly connected to the public low voltage power supply network that supplies buildings used for domestic purposes.

Guidance and manufacturer's declaration – electromagnetic immunity			
Immunity test	IEC 60601-1-2 test level	Compliance level	Electromagnetic environment – guidance
Electrostatic discharge (ESD)	±2kV, ±4kV, ±8kV, ±15kV air	±2kV, ±4kV, ±8kV, ±15kV air	Floors should be wood, concrete or ceramic tile. If floors are covered with synthetic material, the relative humidity should be at least 30%.
EN 61000-4-2	±8kV contact	±8kV contact	



# Electromagnetic Compatibility

Conducted disturbances induced by RF fields EN 61000-4-6	3V in 0,15 MHz to 80 MHz 6V in ISM and amateur radio bands between 0,15 MHz and 80 MHz 80% AM at 1 kHz	3V in 0,15 MHz to 80 MHz 6V in ISM and amateur radio bands between 0,15 MHz and 80 MHz 80% AM at 1 kHz	Portable and mobile RF communications equipment should be used no closer to any part of the product, including cables, than 1.0m, if the transmitter's output power rating exceeds 1W <sup>a</sup> Field strengths from fixed RF transmitters, as determined by an electromagnetic site survey, should be less than the compliance level in each frequency range <sup>b</sup> Interference may occur in the vicinity of equipment marked with this symbol: 
Radiated RF electromagnetic field EN 61000-4-3	Home Healthcare environment 10 V/m 80 MHz to 2,7 GHz 80% AM at 1 kHz	Home Healthcare environment 10 V/m 80 MHz to 2,7 GHz 80% AM at 1 kHz	
Proximity fields from RF wireless communications equipment EN 61000-4-3	385 MHz - 27 V/m 450 MHz - 28 V/m 710, 745, 780 MHz - 9V/m 810, 870, 930 MHz - 28 V/m 1720, 1845, 1970, 2450 MHz – 28 V/m 5240,5500, 5785 MHz - 9V/m	385 MHz - 27 V/m 450 MHz - 28 V/m 710, 745, 780 MHz - 9V/m 810, 870, 930 MHz - 28 V/m 1720, 1845, 1970, 2450 MHz – 28 V/m 5240,5500, 5785 MHz - 9V/m	
Electrical fast transient/burst EN 61000-4-4	±1kV SIP/SOP ports 100 kHz repetition frequency	±1kV SIP/SOP ports 100 kHz repetition frequency	
Power frequency Magnetic field EN 61000-4-8	30 A/m 50 Hz or 60 Hz	30 A/m 50 Hz	Power frequency magnetic fields should be at levels characteristic of a typical location in a typical commercial or hospital environment.

<sup>a</sup> Field strengths from fixed transmitters, such as base stations for radio (cellular/cordless) telephones and land mobile radios, amateur radio, AM and FM radio broadcast and TV broadcast cannot be predicted theoretically with accuracy. To assess the electromagnetic environment due to fixed RF transmitters, an electromagnetic site survey should be considered. If the measured field strength in the location in which the product is used exceeds the applicable RF compliance level above, the product should be observed to verify normal operation. If abnormal performance is observed, additional measures may be necessary.

<sup>b</sup> Over the frequency range 150 kHz to 80 MHz, field strengths should be less than 1 V/m.

**!** **Caution:** Operating the product near a strong electro-magnetic field may affect the displayed weight measurement.  
These changes does not affect user safety.

Intentionally left blank

**AUSTRALIA**

Arjo Australia  
Building B, Level 3  
11 Talavera Road  
Macquarie Park, NSW, 2113,  
Australia  
Phone: 1800 072 040

**BELGIQUE / BELGIË**

Arjo Belgium  
Evenbroekveld 16  
9420 Erpe-Mere  
Phone: +32 (0) 53 60 73 80  
Fax: +32 (0) 53 60 73 81  
E-mail: info.belgium@arjo.com

**BRASIL**

Arjo Brasil Equipamentos Médicos Ltda  
Rua Marina Ciufuli Zanfelice, 329 PB02  
Galpão - Lapa  
São Paulo – SP – Brasil  
CEP: 05040-000  
Phone: 55-11-3588-5088  
E-mail: vendas.latam@arjo.com  
E-mail: servicios.latam@arjo.com

**CANADA**

Arjo Canada Inc.  
90 Matheson Boulevard West  
Suite 300  
CA-MISSISSAUGA, ON, L5R 3R3  
Tel/Tél: +1 905 238 7880  
Free: +1 800 665 4831 Institutional  
Free: +1 800 868 0441 Home Care  
Fax: +1 905 238 7881  
E-mail: info.canada@arjo.com

**ČESKÁ REPUBLIKA**

Arjo Czech Republic s.r.o.  
Na Strži 1702/65  
140 00 Praha  
Czech Republic  
Phone No: +420225092307  
e-mail: info.cz@arjo.com

**DANMARK**

Arjo A/S  
Vassingerødvej 52  
DK-3540 LYNGE  
Tel: +45 49 13 84 86  
Fax: +45 49 13 84 87  
E-mail:  
dk\_kundeservice@arjo.com

**DEUTSCHLAND**

Arjo GmbH  
Peter-Sander-Strasse 10  
DE-55252 MAINZ-KASTEL  
Tel: +49 (0) 6134 186 0  
Fax: +49 (0) 6134 186 160  
E-mail: info-de@arjo.com

**ESPAÑA**

ARJO IBERIA S.L.  
Poligono Can Salvatella  
c/ Cabanyes 1-7  
08210 Barberà del Valles  
Barcelona - Spain  
Telefono 1: +34 900 921 850  
Telefono 2: +34 931 315 999

**FRANCE**

Arjo SAS  
2 Avenue Alcide de Gasperi  
CS 70133  
FR-59436 RONCQ CEDEX  
Tél: +33 (0) 3 20 28 13 13  
Fax: +33 (0) 3 20 28 13 14  
E-mail: info.france@arjo.com

**HONG KONG**

Arjo Hong Kong Limited  
Room 411-414, 4/F, Manhattan Centre,  
8 Kwai Cheong Road, Kwai Chung, N.T.,  
HONG KONG  
Tel: +852 2960 7600  
Fax: +852 2960 1711

**ITALIA**

Arjo Italia S.p.A.  
Via Giacomo Peroni 400-402  
IT-00131 ROMA  
Tel: +39 (0) 6 87426211  
Fax: +39 (0) 6 87426222  
E-mail: Italy.promo@arjo.com

**MIDDLE EAST**

Arjo Middle East FZ-LLC  
Office 908, 9th Floor,  
HQ Building, North Tower,  
Dubai Science Park,  
Al Barsha South  
P.O Box 11488, Dubai,  
United Arab Emirates  
Direct +971 487 48053  
Fax +971 487 48072  
Email: Info.ME@arjo.com

**NEDERLAND**

Arjo Nederland BV  
Biezenwei 21  
4004 MB TIEL  
Postbus 6116  
4000 HC TIEL  
Tel: +31 (0) 344 64 08 00  
Fax: +31 (0) 344 64 08 85  
E-mail: info.nl@arjo.com

**NEW ZEALAND**

Arjo Ltd  
34 Vestey Drive  
Mount Wellington  
NZ-AUCKLAND 1060  
Tel: +64 (0) 9 573 5344  
Free Call: 0800 000 151  
Fax: +64 (0) 9 573 5384  
E-mail: nz.info@Arjo.com

**NORGE**

Arjo Norway AS  
Olaf Helsets vei 5  
N-0694 OSLO  
Tel: +47 22 08 00 50  
Faks: +47 22 08 00 51  
E-mail: no.kundeservice@arjo.com

**ÖSTERREICH**

Arjo GmbH  
Lemböckgasse 49 / Stiege A / 4.OG  
A-1230 Wien  
Tel: +43 1 8 66 56  
Fax: +43 1 866 56 7000

**POLSKA**

Arjo Polska Sp. z o.o.  
ul. Ks Piotra Wawrzyniaka 2  
PL-62-052 KOMORNIKI (Poznań)  
Tel: +48 61 662 15 50  
Fax: +48 61 662 15 90  
E-mail: arjo@arjo.com

**PORTUGAL**

Arjo em Portugal  
MAQUET Portugal, Lda.  
(Distribudor Exclusivo)  
Rua Poeta Bocage n.º 2 - 2G  
PT-1600-233 Lisboa  
Tel: +351 214 189 815  
Fax: +351 214 177 413  
E-mail: Portugal@arjo.com

**SUISSE / SCHWEIZ**

Arjo AG  
Fabrikstrasse 8  
Postfach  
CH-4614 HÄGENDORF  
Tél/Tel: +41 (0) 61 337 97 77  
Fax: +41 (0) 61 311 97 42

**SUOMI**

Arjo Scandinavia AB  
Riihitontuntie 7 C  
02200 Espoo  
Finland  
Puh: +358 9 6824 1260  
E-mail: Asiakaspalvelu.finland@arjo.com

**SVERIGE**

Arjo International HQ  
Hans Michelsensgatan 10  
SE-211 20 MALMÖ  
Tel: +46 (0) 10 494 7760  
Fax: +46 (0) 10 494 7761  
E-mail: kundservice@arjo.com

**UNITED KINGDOM**

Arjo UK and Ireland  
Houghton Hall Park  
Houghton Regis  
UK-DUNSTABLE LU5 5XF  
Tel: +44 (0) 1582 745 700  
Fax: +44 (0) 1582 745 745  
E-mail: sales.admin@arjo.com

**USA**

Arjo Inc.  
2349 W Lake Street Suite 250  
US-Addison, IL 60101  
Tel: +1 630 307 2756  
Free: +1 800 323 1245 Institutional  
Free: +1 800 868 0441 Home Care  
Fax: +1 630 307 6195  
E-mail: us.info@arjo.com

**JAPAN**

Arjo Japan K.K.  
東京都港区虎ノ門三丁目7番8号  
ランディック第2虎ノ門ビル9階  
Tel: +81 (0)3-6435-6401  
Fax: +81 (0)3-6435-6402  
E-mail: info.japan@arjo.com

At Arjo, we are committed to improving the everyday lives of people affected by reduced mobility and age-related health challenges. With products and solutions that ensure ergonomic patient handling, personal hygiene, disinfection, diagnostics, and the effective prevention of pressure ulcers and venous thromboembolism, we help professionals across care environments to continually raise the standard of safe and dignified care. Everything we do, we do with people in mind.



ArjoHuntleigh AB  
Hans Michelsensgatan 10  
211 20 Malmö, Sweden  
[www.arjo.com](http://www.arjo.com)

**arjo**

**CE**  
2797