

INSTRUCTIONS FOR USE

# Maxi Sky 440



## Design Policy and Copyright

® and ™ are trademarks belonging to the Arjo group of companies.

© Arjo 2020.

As our policy is one of continuous improvement, we reserve the right to modify designs without prior notice. The content of this publication may not be copied either whole or in part without the consent of Arjo.

# Table of Contents

<b>General Information</b> .....	<b>5</b>
Foreword .....	5
Service and Support .....	5
Manufacturer Information .....	5
Definitions Used in this Manual .....	6
Intended Use .....	6
Operational Life .....	6
Product Identification .....	6
Package Contents .....	6
How to Use this Manual .....	6
Symbols Used .....	7
<b>Safety Instructions</b> .....	<b>8</b>
General Instructions .....	8
Addendum for Rail Systems other than KWIKtrak™ .....	8
Safe Working Load .....	8
Important Safety Directions .....	9
Shock Prevention .....	9
Fire and Explosion Prevention .....	9
Human and Environmental Safety Practices .....	10
Battery and Battery Charger Safety Practices .....	10
Equipment Warning Labels .....	10
Homecare Environment Considerations .....	10
<b>Product Description</b> .....	<b>11</b>
<i>Maxi Sky 440</i> Portable Lift and Charger Station .....	11
Hand Control .....	12
Charger .....	12
Indicators .....	12
<b>Accessories</b> .....	<b>13</b>
<b>Slings</b> .....	<b>14</b>
Compatible Slings .....	14
<b>How to Use the <i>Maxi Sky 440</i></b> .....	<b>15</b>
Use of Slings .....	15
Before Approaching the Patient .....	15
Positioning the Patient .....	15
Attachment Methods .....	15
Transferring the Patient .....	16
Emergency Shut-off .....	17
Emergency Lowering .....	17
Emergency Brake .....	18
Battery Information .....	19
Charging the Batteries .....	19
<b>Care and Maintenance</b> .....	<b>20</b>
Preventive Maintenance Schedule .....	20
User Inspections .....	20
Inspections by an Authorized Service Technician .....	21
Daily Checklist .....	22
Cleaning .....	22
<i>Maxi Sky 440</i> 's Special Areas to Clean .....	22
Strap Inspection .....	23
Handling and Storage .....	23
Battery Replacement .....	23
Verification of the Charger's Power Source .....	23

# Table of Contents

---

Sling Inspection and Care .....	24
Annual Inspection .....	24
Maintenance Requirements .....	24
<b>Troubleshooting.....</b>	<b>25</b>
<b>Labels on the Lift .....</b>	<b>26</b>
<b>Technical Specifications .....</b>	<b>27</b>
Lift Dimensions .....	28
<b>Electromagnetic Compatibility .....</b>	<b>29</b>
Electromagnetic Compliance.....	29
Electromagnetic Emissions.....	29
Electromagnetic Immunity.....	30

# General Information

Thank you for buying the *Maxi Sky*<sup>®</sup> 440 portable lift from Arjo.

Your *Maxi Sky 440* is part of a series of quality products designed specially for home care, nursing homes and other health care uses.

We are dedicated to serving your needs and providing the best products available along with training that will bring your staff maximum benefit from every Arjo product.

Contact us if you have any questions about the use or maintenance of your Arjo product.

## Foreword

Please read this manual in its entirety. The information contained in it is crucial to the proper use and maintenance of the *Maxi Sky 440*. It will help protect your product as well as ensure that the equipment performs to your satisfaction.

Lifting and transferring a person always present a potential risk. Some of the information in this manual is important for your safety and must be read and understood to help prevent injuries.

If a serious incident occurs in relation to this medical device, affecting the user, or the patient then the user or patient should report the serious incident to the medical device manufacturer or the distributor. In the European Union, the user should also report the serious incident to the Competent Authority in the member state where they are located.

**WARNING: Arjo strongly advises and warns that only parts designated by Arjo should be used on products and other devices supplied by Arjo. Injuries can be caused by the use of inadequate parts.**

**WARNING: Unauthorized changes on any Arjo product may affect its safety. Arjo will not be held responsible for any accidents, incidents or deficiencies of performance that occur as a result of any unauthorized changes to its products.**

Tested according to standards by: 

## Service and Support

A service routine must be done on your *Maxi Sky 440* by Arjo trained service staff. This will ensure the product remains safe and functional. See “Care and Maintenance” section.

Please contact your local Arjo agent if you need more information, want to report an unexpected event or need any help in setting up, using or maintaining your *Maxi Sky 440*. The agent can offer support and service programs to maximize the long-term safety, reliability and value of the product.

Contact your local agent for replacement parts.

Additional copies of this manual can be bought from your local Arjo agent. When ordering, include the *Instructions for Use* part number (see *front page*) and the product part number.

## Manufacturer Information

**This product has been manufactured by:**

ArjoHuntleigh AB  
Hans Michelsensgatan 10  
211 20 Malmö,  
SWEDEN

☎: +46 (0) 10-335 45 00

☎: +46 (0) 413-138 76

🌐: [www.arjo.com](http://www.arjo.com)

# General Information

## Definitions Used in this Manual

### WARNING:

**Means:** Failure to follow these instructions may result in injury to yourself and others.

### CAUTION:

**Means:** Failure to follow these instructions may cause damage to the product.

### NOTE:

**Means:** This is important information regarding the correct use of the equipment.

## Intended Use

The Maxi Sky 440 is designed to assist caregivers in hospitals, long-term care, nursing homes and home care environment, including private homes & patients with reduced mobility for these reasons:

- 1) Transferring to/from adjacent location, such as chair, wheelchair, bed, bath, toilet, floor or stretcher;
- 2) Supporting the patient for rehabilitation training;
- 3) Assisting patient with tasks such as, toileting and bed positioning.

Patient transfers must be done under the supervision of appropriately trained caregivers in accordance with the instructions found in this manual. The product must only be used for the reasons stated above. It must be installed by Arjo authorized personnel, following local codes.

## Operational Life

The product is designed and tested for a useful life of seven (7) years or 10,000 transfers—whichever comes first—when subject to preventive maintenance as specified in the “Care and Maintenance” section.

Time equivalence between the number of transfers versus the number of years is made clear in the table in Fig. 1.

Transfers per Day	Years (10,000 transfers)
4	7
6	4.5
8	3.5

Fig. 1

**WARNING:** The manufacturer cannot ensure full safety for a portable lift or an accessory of which the life span has been exceeded. Wear may cause the breakage of a part and lead to a patient fall.

The red indicator light on the portable lift will blink when it is about halfway to its useful life, and again to indicate the end of the useful life period.

Aging of the cassette, frequency of use (transfers per day), the weight of the patient and maintenance frequency are factors that have an impact on the Maxi Sky 440's life span.

A transfer is defined as the displacement of a patient from one point to another. A transfer cycle includes a lifting and a descending action.

The expected operational life for fabric slings and stretchers is approximately 2 years from purchase date. The life expectancy only applies if the slings and stretchers have been cleaned, maintained and inspected in accordance with the “Preventive Maintenance Schedule.”

The expected life for other consumable products, such as batteries, fuses, lamps, slings, straps and cords is dependent upon the care and usage of the product concerned. Consumables must be maintained in accordance with published *Instructions for Use* and the “Preventive Maintenance Schedule”.

## Product Identification

The unit's identification number (specification, model, serial number) appears on a silver nameplate affixed below the casing (see Fig. 17 on page 26).

## Package Contents

Upon receipt of the equipment, verify it against the packing list to ensure it is complete. Inspect it for possible damage due to shipping. If this the case, contact your local Arjo agent.







## How to Use this Manual



**WARNING:** Do not attempt to use this lift without fully understanding the information contained in this manual. A misuse of this unit may lead to a patient fall and to injuries.

Keep this manual with the lift and refer to it as required.

# General Information

## Symbols Used

General Symbols	Key to symbols
	Points out the date of manufacture and the address of the manufacturer.
	CE marking indicating conformity with European Community harmonised legislation.
	Points out the approval of the Canadian Standards Association.
<b>REF</b>	Is accompanied by the manufacturer's catalogue number.
<b>SN</b>	Is accompanied by the manufacturer's serial number.
	Refers to the <i>Instructions for Use</i> .
	Waste Electrical and Electronic Equipment (WEEE) - do not dispose of this product in general household or commercial waste.
	Points out a risk of pinching.
<b>SWL</b>	Represents the maximum load the lifte is rated for safe operation.
<b>IP<sub>N<sub>1</sub></sub>N<sub>2</sub></b>	Points out the degree of protection provided by enclosure. N <sub>1</sub> : Ingress of particles, N <sub>2</sub> : Ingress of water.
	Direct current.

General Symbols	Key to symbols
	Alternating current.
	Points out a type BF applied part.
	Indicates the product is a Medical Device according to EU Medical Device Regulation 2017/745.

Charger Related Symbols	Key to symbols
	Points out a class II electrical equipment: term referring to electrical equipment in which protection against electric shock does not rely on basic insulation only.

# Safety Instructions

---

If there is anything you are not sure about, or if you notice any changes in the performance of your lift, contact your local Arjo agent.

## General Instructions.

**CAUTION:** The *Maxi Sky 440* is for transferring patients only. Do not use it for any other reason. It could get damaged and the safety of the patient may be compromised.

**WARNING:** Always place the sling around the patient according to the instructions found therein. Failure to do so may result in injuries to you or to others.

**CAUTION:** Do not drop the lift. It may cause internal damage. If the portable lift is suspected to be damaged, contact your local Arjo agent.

**NOTE:** Arjo lifts are specifically designed for KWIKtrak™ rail systems, Arjo slings and accessories.

## Addendum for Rail Systems other than KWIKtrak™

Arjo could have adapted this lift cassette to be used with a rail system other than *KWIKtrak*. If this is the case, an addendum (001-14350-XX) must be supplied with this *Instructions for Use*. This document provides important information relative to:

- Rail system limitations;
- Descriptions of specific parts.

**WARNING:** Before using the *Maxi Sky 440* with a rail system other than *KWIKtrak*, make sure you have read and understood the addendum supplied with the adapted accessory.

## Safe Working Load

The *Maxi Sky 440* has been designed with a lifting capacity of 200 kg (440 lb).

**WARNING:** The *Maxi Sky 440* is intended to be used for patients whose weight is within a specified safe working load. Do not attempt to lift more than the lowest weight limit indicated on the following:

- the rail system;
- the “maximum load” label on the lift;
- the accessories;
- the sling.

Surcharge of any of these elements may lead to a patient fall and to injuries.



# Safety Instructions

## Important Safety Directions

Always ensure that:

- The portable lift was installed by an approved Arjo contractor or installer.
- The product is used by trained caregivers.
- The rail installation will accept a load equal or higher to that of the portable lift.

**WARNING: Before attempting a transfer, a clinical assessment of the patient's suitability for transfer should be carried out by a qualified health professional. The transfer, among other things, may induce substantial pressure on the patient's body. A transfer conducted when it should not can degrade the patient's health condition.**

- Special consideration is taken with a patient who is connected to electrodes, catheters or other medical devices.
- Violent impact during transfers is avoided.
- The sling is not damaged, torn or frayed.
- The lifting procedures found in this manual are followed.
- All controls and safety features are used only according to the rules specified in this manual. Never attempt to force a control or button on the lift.
- The charger is not stored in a shower, bath or other areas with high humidity.
- The sling straps are in good condition and properly fastened.
- The daily maintenance is carried out before using the lift.
- If storing the lift, the humidity in the storage area does not exceed 100%.
- The ambient temperature range when storing the *Maxi Sky 440* remains between  $-25^{\circ}\text{C}$  and  $70^{\circ}\text{C}$  ( $-13^{\circ}\text{F}$  to  $158^{\circ}\text{F}$ ).

**WARNING: This product contains small parts that might present a choking hazard for children if swallowed or inhaled.**

**WARNING: Arjo warns of possible strangulation risks related to the lifting strap or the hand control cable. Necessary precautions should be taken to prevent these.**

**CAUTION: Keep all components of the lift clean and dry to avoid a malfunction of the device.**

**CAUTION: Excessive exposure of the hand control to water (or other liquids) could cause a malfunction of the device.**

## Shock Prevention

- Do not touch or use a lift with bare conductors or a damaged power cord. If this is the case, contact your local Arjo agent immediately.
- Do not expose the unit to water or moisture.
- Check nameplate for input voltage and frequency requirements. These ones differ by country. Do not attempt to use the lift in an area that has a different voltage and frequency requirement.
- Do not attempt to expose, service or repair the lift, battery or charger. If the unit is malfunctioning, contact your local Arjo agent.
- Read batteries and charger instructions carefully before using or storing them.

## Fire and Explosion Prevention

**WARNING: Do not place or store the battery under direct sunlight or near a heat source.**

**WARNING: Do not expose the batteries or battery charger to flames. They might open, causing a chemical leak.**

**WARNING: Do not use the charger in the presence of flammable anaesthetic gases. These are inflammables. The charger might generate a spark, which could cause an implosion.**

- Do not short circuit the battery terminals.
- Do not incinerate the battery.

# Safety Instructions

## Human and Environmental Safety Practices

- Should the battery casing crack and cause contents to come in contact with skin or clothing, rinse immediately with plenty of water.
- If contents come in contact with the eyes, rinse immediately with plenty of water and seek medical attention.
- Inhalation of the contents can cause respiratory irritation. Provide fresh air and medical attention.
- For recycling and disposal of the batteries, the rules according to the WEEE directive (Waste of Electronic and Electrical Equipment) as well as local laws and regulations must be followed. If not they may explode, leak and cause personal injury. When returning batteries, insulate their terminals with adhesive tape. Otherwise, the residual electricity in used batteries may cause fire or explosion. Fig. 2 below shows the symbols for disposal and recycling.

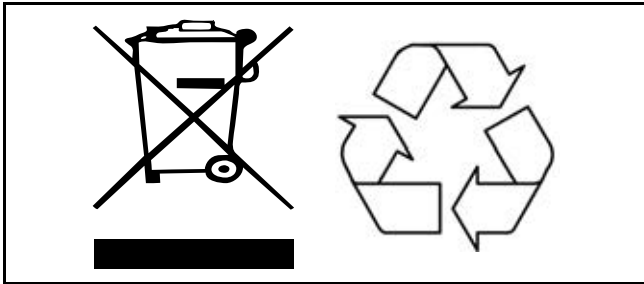

Fig. 2

## Battery and Battery Charger Safety Practices

**WARNING:** Following the instructions is important for the safe use of the battery and to keep the user (resident/caregiver) from harm.

The batteries for this device are rechargeable batteries.

Only use batteries designed for use with the device. If unsure, do not use the battery. Make sure the battery belongs to the device by comparing the battery label with the technical specifications in the *Instructions for Use*. If battery type cannot be confirmed, call your Arjo agent.

- Do not expose the battery charger or connector to water.
- Do not expose the battery or chargers to flames.

To avoid bodily injury, do not crush, puncture, open, dismantle or otherwise mechanically interfere with the battery.

Stop using the battery if any damage or deformation is noted. Inform technical service before further use.

Please see the “Technical Specifications” in this document for correct disposal and recycling of the battery.

- Be careful not to drop the batteries.
- Only use the charger that has been supplied with the lift.
- Do not charge the batteries in an unventilated area.
- The charger must not be covered or exposed to dust.
- The charger is designed for dry areas only and for normal air humidity conditions.
- Do not store batteries at a temperature higher than 70°C (158°F).

## Equipment Warning Labels

- Carefully read the labels on the battery and follow the instructions.
- Inspect all precautionary labels on the equipment. Order and replace all labels that cannot be easily read.

## Homecare Environment Considerations

**WARNING:** The *Maxi Sky 440* is not intended to be operated by children. Serious injuries could occur.

**NOTE:** Rigorous cleaning actions should be done when the *Maxi Sky 440* is exposed to an animal. Pet hair trapped inside the device (through the strap opening) can reduce the product performance.

# Product Description

## Maxi Sky 440 Portable Lift and Charger Station

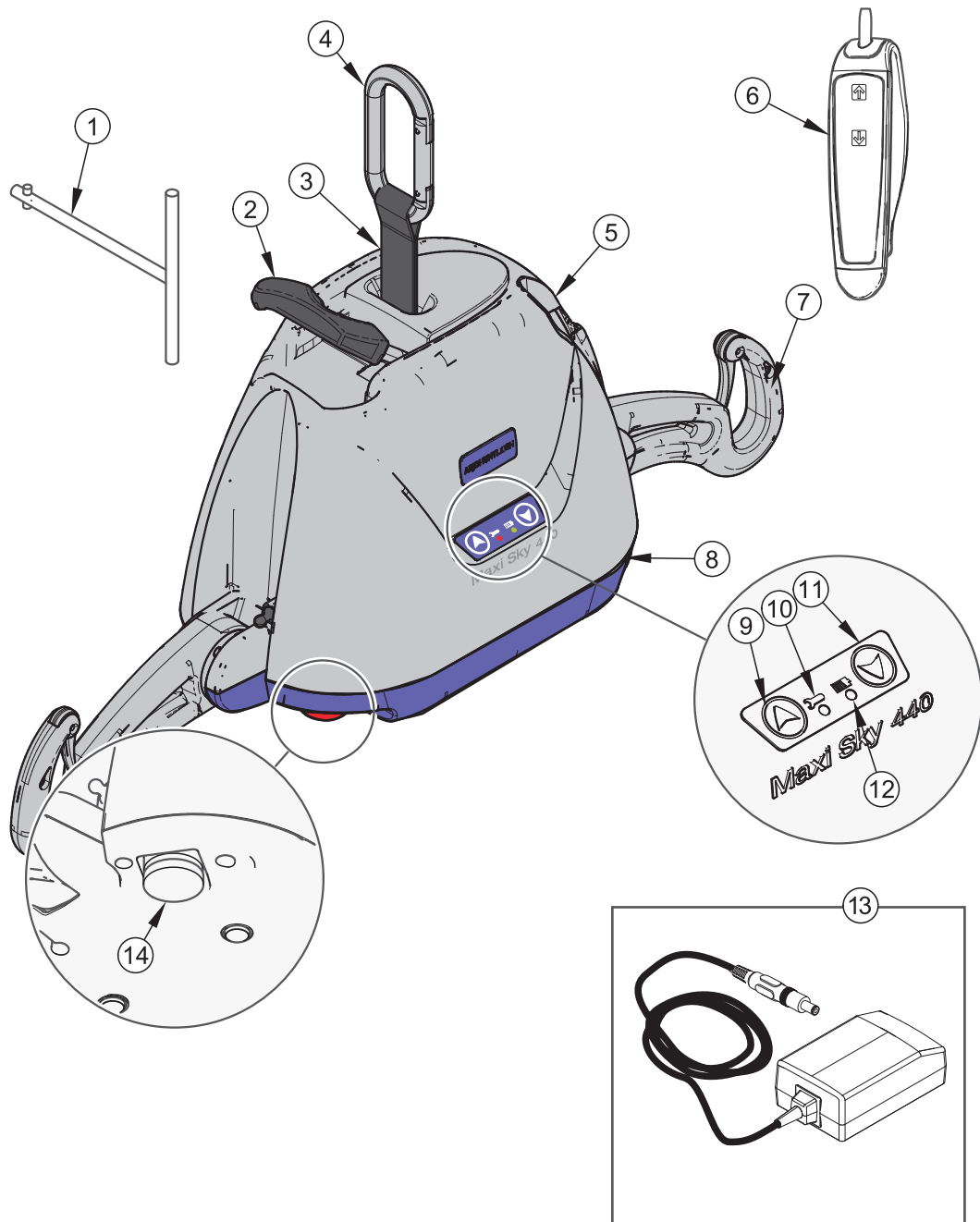

### Legend

- |                            |                                  |
|----------------------------|----------------------------------|
| 1) Emergency lowering tool | 8) DC charger inlet              |
| 2) Pass through hook       | 9) UP button                     |
| 3) Strap                   | 10) Maintenance indicator light  |
| 4) Carabiner               | 11) DOWN button                  |
| 5) Hand control holder     | 12) Charge indicator light       |
| 6) Hand control unit       | 13) Charger (with mains adaptor) |
| 7) Support                 | 14) Emergency shut-off button    |

Fig. 3

# Product Description

## Hand Control

The *Maxi Sky 440*'s hand control unit is used to operate the portable lift. Each function is described in . The UP and DOWN buttons raise or lower the lift.

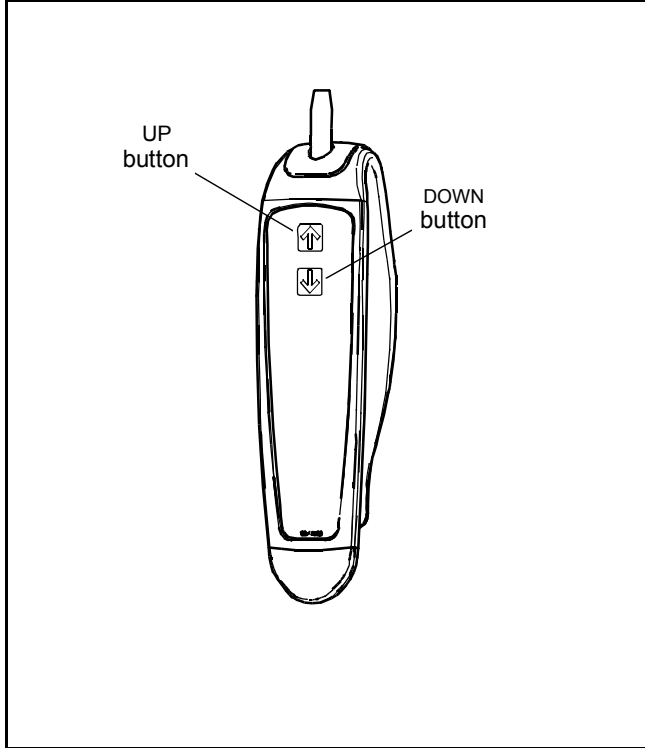

Fig. 4

## Charger

The *Maxi Sky 440* units are equipped with a wall-adapted charger (see Fig.3) that can be customized to fit the AC voltage outlets where they are sold.

**Note: Avoid positioning the charger such that access to the plug is limited, making disconnection difficult.**

## Indicators



BATTERIES STATUS		
(Yellow) 	Flashing	In process of charging batteries.
	Solid	Charging done; batteries charged.
MAINTENANCE		
(Red) 	Flashing (no beep)	Maintenance required by your local agent.
	Solid (with beep)	Maintenance in overdue. Stop using the lift and contact your local agent for service.

Fig. 5



# Accessories

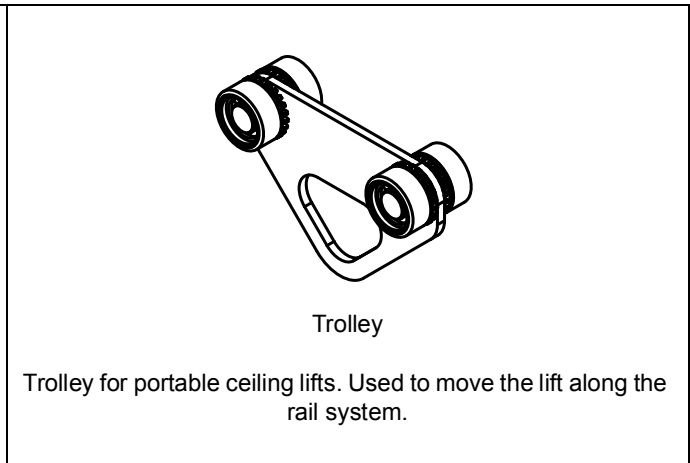
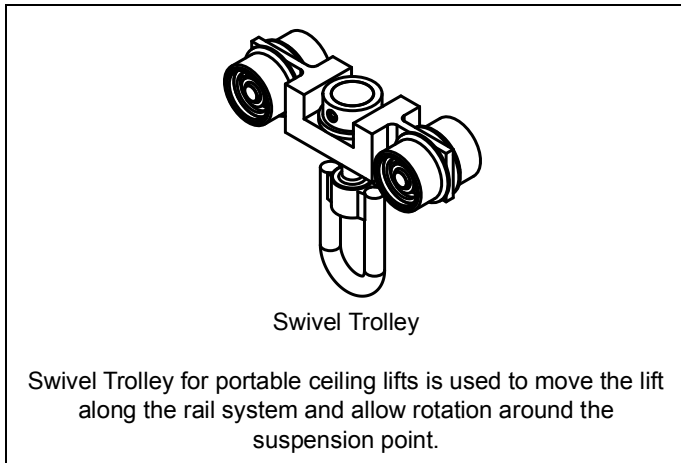
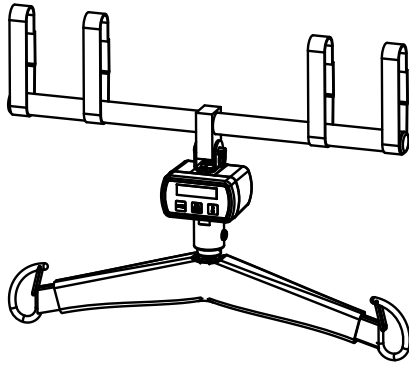

Scale

To use the scale with the scale adaptor, refer to the scale IFU and the scale adaptor IFU.

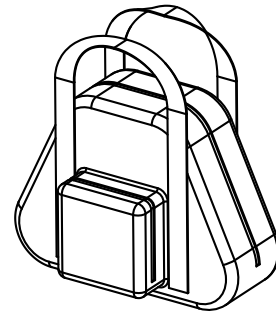

Carry Bag

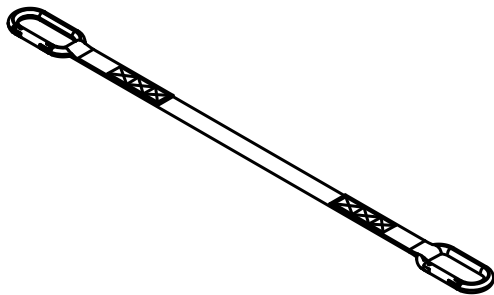

Strap Extension

To use the Strap Extension, refer to the Strap Extension IFU.



Swivel Adaptor

Swivel Adaptor is used to allow lift rotation around the suspension point.

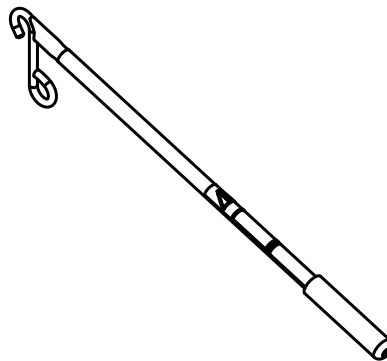

Reacher 24" & 36"

To use the Reacher, refer to the Reacher IFU.

Fig. 6

Refer to your local Arjo agent for ordering.

**WARNING: All trolleys are not compatible with all rail systems. Please contact your local Arjo agent to get more information.**

# Slings

## Compatible Slings

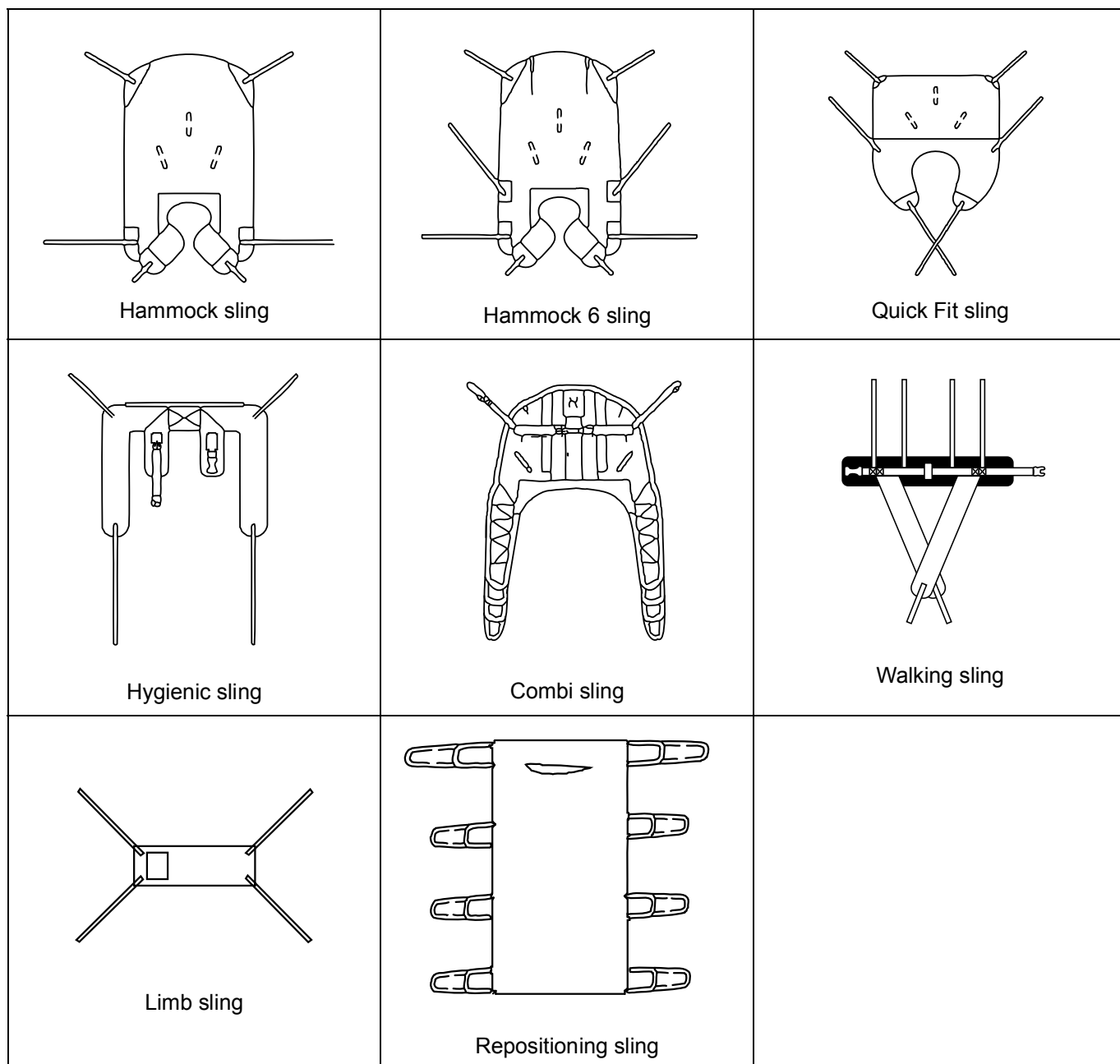

Fig. 7

Refer to your local Arjo agent for ordering.

# How to Use the Maxi Sky 440

**WARNING: All rails must be closed with end stoppers or connected to other closed rail components. Before use, make sure all end stoppers are in place and secured. A wrong installation of these items might lead to a patient fall and to injuries.**

**WARNING: The lift must never be operated by the patient. In the unlikely case of a failure, the patient might get stuck in the unit.**

## Use of Slings

The 2 sling supports can accommodate any of the Arjo loop attachment slings.

All slings are color coded for size by having a different colored edge binding or attachment strap coloring:

- Grey or Teal - Extra Extra Small - XXS
- White or Brown - Extra Small - XS
- Red - Small - S
- Yellow - Medium - M
- Green - Large - L
- Blue - Extra Large - XL
- Terracotta - Extra Extra Large - XXL

Arjo offers the option of a headrest for many slings if it is considered necessary for a particular patient. A range of special purpose slings are available as accessories. For these or for special size slings, contact your Arjo agent.

**WARNING: When using Arjo Flites slings (disposable) with the Maxi Sky 440, always refer to the Arjo Flites operating instructions as well as these instructions before using.**







## Before Approaching the Patient

Attendants should always tell the patient what they are about to do. Make sure to have on hand a sling that is of the correct model and of adequate size for transfer with the *Maxi Sky 440*.

Before performing the transfer, it is important to evaluate the patient's general condition. For example, an agitated patient will require a more specific type of sling.

## Positioning the Patient

The specific sling loops chosen determine the position of the patient. Different loop combinations can be used to allow the patient to be lifted and transferred in positions ranging from semi-reclined to seated.

BODY POSITION ACCORDING TO SELECTION OF LOOP STRAPS			
SHOULDERS	SHOULDERS	LEGS	HIPS*
			
	3	1	2
	2	1	2
	1	1	2
	1	2	1

\*Hip loops only available on THA6i model

**NOTE: Slings with more loops allow additional alternative positions.**

## Attachment Methods

Once the loop sling has been fitted around the patient, it can be configured in three ways. With each of the three methods described below, it is necessary to first connect each shoulder loop of the sling to both sides of the spreader bar.

### Attachments Points

The attachment point designation shown here are only for the purpose of the explanations below.

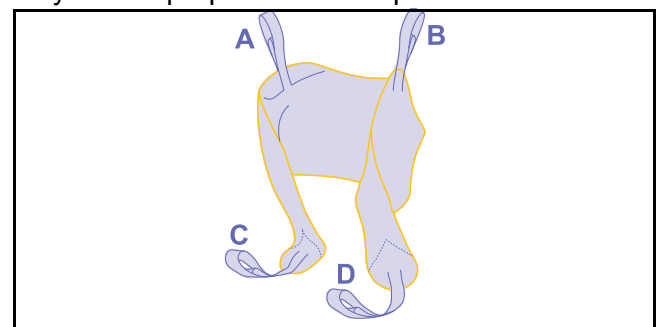

Fig. 8

# How to Use the Maxi Sky 440

## Method 1 - Cross-through

(Legs closed with crossing straps)

This method is recommended for most general transfer (see Fig. 9).

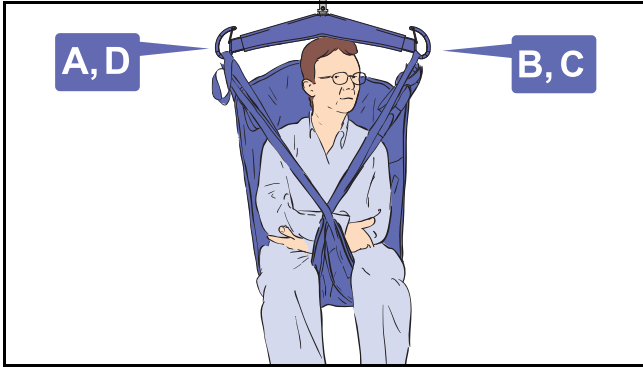

Fig. 9

## Method 2 - Hammock

(Bridge, legs closed)

This method can provide a comfortable cradle for amputee patient.

It is also a useful method for patients with contractures, making it difficult to bring a sling strap between the legs (see Fig. 10).

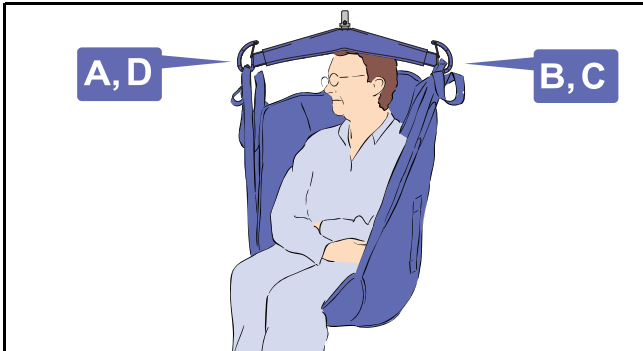

Fig. 10

**WARNING:** This method might not be suitable for confused, combative or erratic patients as they can fall forward and get injured.

## Method 3 - Abduction

(Legs opened with non-crossing straps)

In this method, legs are held in abduction which is convenient for toileting and hygiene care (see Fig. 11).



Fig. 11

**WARNING:** This method might not be suitable for patients with no upper body control as they can slide down and almost out of the sling.

## Transferring the Patient

To begin the transferring procedure:

- 1) Install the patient into the sling according to the "Installing a Patient into the Sling" section.
- 2) Unwind the strap by pressing the DOWN button on the hand control while holding a tension on the strap with the other hand.

**Note:** There must be tension on the strap for the lift to function.

- 3) Attach the carabiner to the trolley and then move the lift over the patient.
- 4) Lower the lift below the chin and unfold supports before attaching the sling straps. (This will prevent the lift from striking the patient's face due to the lift's movement).

**Note:** For a patient in a supine position, lower the lift near the chest, unfold supports, then install the straps.

**NOTE:** The back of the sling has sewn handles to allow better positioning for the caregiver and enhancing patient safety.

- 5) To attach the sling, unfold the support on each side of the lift. Insert the strap loop onto the support and pull gently on the strap.
- 6) The support safety latch will rotate allowing the strap to slide into the hooks. The strap will be trapped inside the support as the safety latch will automatically revert to the closed position. Do not attempt to transfer a patient if the safety latches are not blocking the support's opening for the strap.

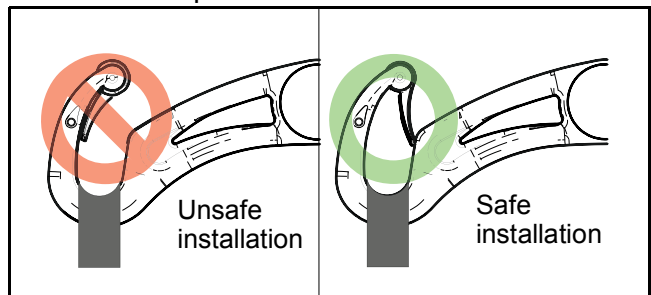

Fig. 12



# How to Use the Maxi Sky 440

## **WARNING: Before lifting the patient:**

- 1) Make sure that all straps are attached to the lift's supports.
- 2) Make sure the patient's arms are safely out of the way.
- 3) Make sure the sling is not caught on any obstructions (wheelchair brake or chair arm, etc.).

If any of the above occurs, lower the patient immediately and correct the problem. Any of these situations might lead to a patient falling.

- 7) To lift the patient, press the UP button on the hand control.
- 8) Lift the unit until the patient's buttocks clear the arm supports of the wheelchair, the top of the bath or the bed before moving the patient. Guide the patient's legs past any obstacles.

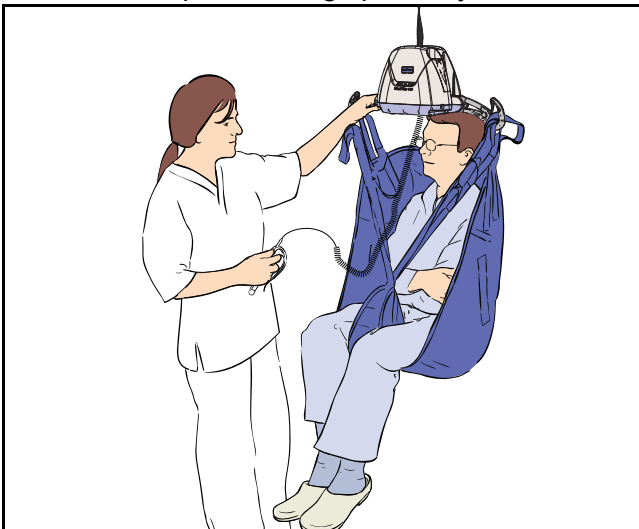

Fig. 13

- 9) When the patient is located above the desired point of transfer and ready to be lowered, press the DOWN button.
- 10) Once the patient is properly seated, loosen the straps and disengage the sling from the lift.

**WARNING: Hold the ceiling lift spreader bar with one hand at all times when near a patient to avoid risk of contact.**

- 11) Slide the lift away from the patient. Unhook the lift from the trolley and use the hand control to shorten the strap. You can now remove the sling from around the patient.

- 12) When the *Maxi Sky 440* is no longer required, plug the portable lift back to the charger.

**WARNING: Constant attention to the patient is required from caregiver during the whole transfer. In the unlikely event of a failure of the device, the caregiver must be ready to react.**

## **Emergency Shut-off**

The operator can shut off the electrical power at any time by pressing the red mushroom-shaped emergency button under the lift. The button is reset by twisting it clockwise in the direction of the arrows. First time users should practice the shut-off manoeuvre before operating the lift with a patient.

## **Emergency Lowering**

The *Maxi Sky 440* has a special safety feature that allows the lift to be lowered even if the electrical system does not operate.

Located on the right side of the lift (near the folding sling support), the emergency lowering device is activated by the insertion of the special tool included with this manual.

To lower safely a patient, follow these steps, as illustrated in Fig. 14:

- 1) Press on the red, emergency shut-off button under the lift. Move the lift with the patient over the bed or the wheelchair.
- 2) Remove the plastic cap covering the emergency lowering mechanism's entry.
- 3) Insert the special tool into the opening. Turn it clockwise to lower the patient. The tool rotation turns the motor directly, so that for each tool turn, the patient will lower slightly. Once the patient is lowered safely on a bed or into a wheelchair, remove the tool from the lift. Call a qualified technician to service your *Maxi Sky 440*.

**CAUTION: The emergency lowering feature is to be used only in case of emergency.**

# How to Use the Maxi Sky 440

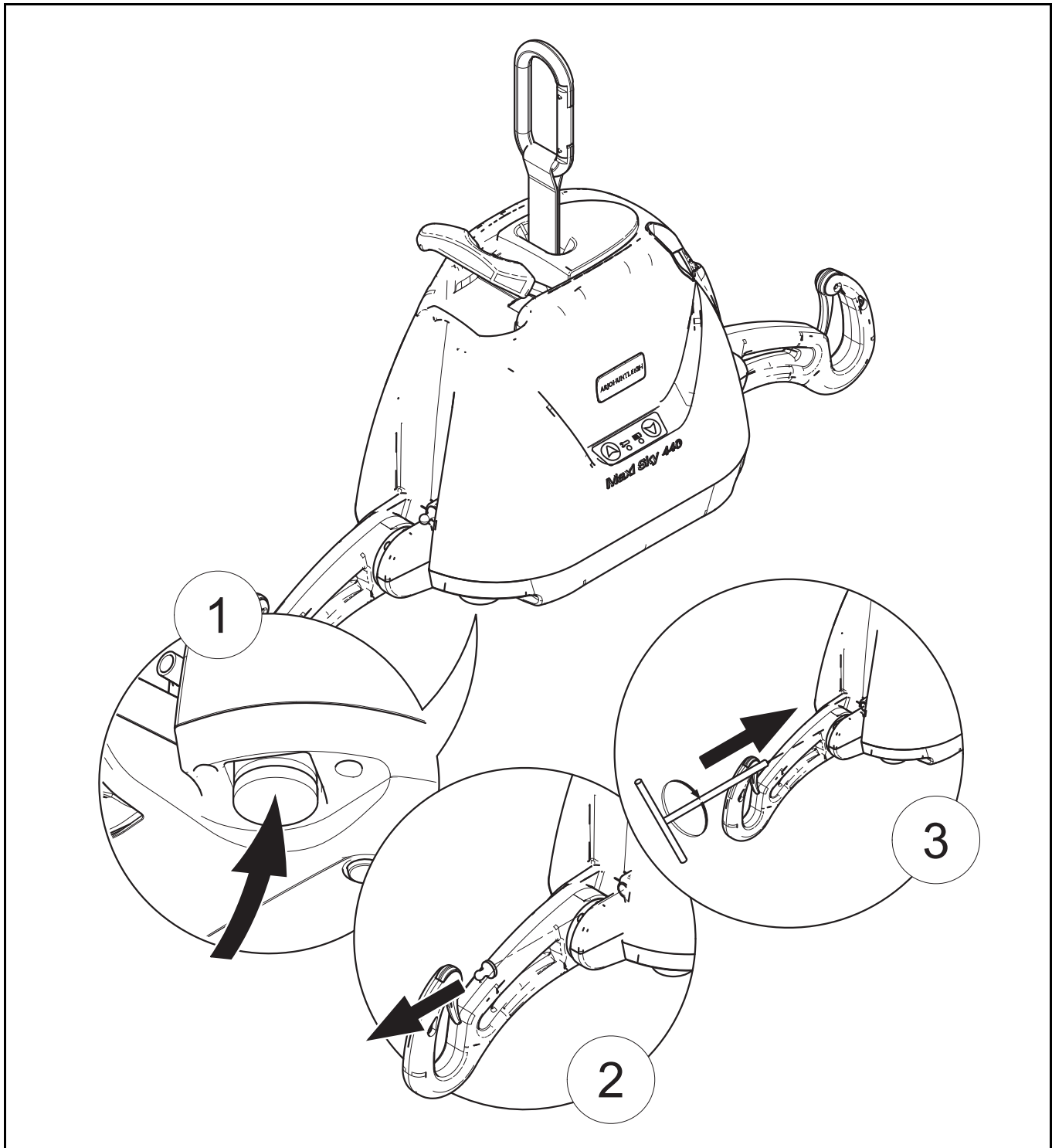

Fig. 14

## Emergency Brake

The emergency brake is an additional safety feature that automatically prevents the patient from falling in the unlikely event of a transmission or motor failure.

**WARNING:** After an incident has occurred and the brake was deployed, never attempt to unlock the brake or press the UP button. This may disengage the brake and make the patient fall. The emergency lowering device cannot be used.

**WARNING:** Never use a portable lift with the emergency brake deployed. Use other equipment to lower the patient. Forcing the lift to make it move might lead to patient fall.

The emergency brake is intended for a single activation and therefore can only be used once. Call your Arjo agent for replacement of the unit.

# How to Use the Maxi Sky 440

## Battery Information

For safe handling and to extend the battery lifetime, please follow and remember these instructions.

**WARNING: Not following these instructions can result in a short battery life.**

Only use batteries designed and labelled for use with the device. When not sure, do not use the battery. Make sure the battery belongs to the device by comparing the battery label with the technical specifications in this manual. If battery type cannot be confirmed, call your Arjo agent.

Battery life depends on many factors. These are: frequency of use, frequency of charging, temperature of operation, storage and storage time.

Using lead-acid batteries below a 20% charge can damage the battery resulting in shorter battery life.

Make sure to have a replacement battery ready when needed. Have the facility department keep one in stock.

The batteries included in the *Maxi Sky 440* provide 10 to 30 transfers per battery charge.

**NOTE: To prolong battery life, plug the charger to the lift's DC charger inlet whenever the portable lift is not in use. If the low battery indicator beeps, make sure to recharge the batteries as soon as possible. Charge the batteries until the charging indicator light is a solid yellow before using the lift again. This will extend their life.**

**NOTE: Arjo uses sealed lead-acid batteries. These ones are not affected by any memory effect. Therefore, they should not be completely drained before recharging.**

## Charging the Batteries

**WARNING: Do not operate the charger with a damaged cord or if the lift has been dropped or damaged. Do not bend the power cord by force, or place a heavy object on it. These could damage the cord and may cause fire or electrical shock.**

The steps for recharging the batteries are as follows:

- 1) Plug the charger into a wall socket compatible with universal voltage input from 100 Vac to 240 Vac.

- 2) Plug the charger's DC connector to *Maxi Sky 440* DC inlet.
- 3) The charge indicator blinks yellow while the battery is charging. When batteries are fully charged, the charge indicator will turn solid. The unit is ready to use (see Fig. 5 on page page 12) .
- 4) If the battery is low, it will take approximately 2 hours for a full charge.

**NOTE: The lift cannot use energy from the charger to operate. If you try to activate any function of the lift when plugged to charger, no command will be activated.**

When you need the lift again, unplug the charger.

The charger can remain plugged to the lift indefinitely, which is convenient for overnight charging. The lift can be charged for an extended period of time without damaging either the charger or the batteries.

If the batteries have been completely drained it could take up to 6-8 hours to completely recharge them. In order to reduce the charging time, refrain from completely draining the batteries and leave the portable lift connected to the charger between uses.

**NOTE: If the charge indicator does not go on or blink when the charger is plugged to the lift's DC charger inlet, see the "Troubleshooting" section.**

**CAUTION: Do not attempt to use a battery that was not supplied by Arjo. These batteries are specially designed for Arjo charging systems. Attempting to use an unapproved battery may seriously damage the lift and/or the charger.**

# Care and Maintenance

## Preventive Maintenance Schedule

The equipment is subjected to wear and tear, and the following maintenance instructions must be acted upon when specified to ensure that it remains within its original manufacturing specifications. Care and maintenance must be carried out in accordance with the preventive maintenance schedule below.

Customer obligations must be carried out by qualified personnel in accordance with the instructions in this manual.

**WARNING: The maintenance described in the following checklist is the minimum that the manufacturer recommends. In some cases more frequent inspections should be carried out. Continuing to use this equipment without conducting regular inspections or when a fault is found will seriously compromise the safety of the user and of the patient. Local regulations and standards may be higher than those of the manufacturer. A load test is recommended. Service and preventative maintenance can be arranged with the manufacturer. Preventive maintenance specified in this manual can prevent accidents and reduce repair costs.**

**WARNING: Safety related maintenance and authorized service must be carried out by qualified personnel, fully trained in servicing procedures by Arjo, and equipped with correct tools and proper documentation, including Parts List and Service Manual. Failure to meet these requirements could result in injuries and/or unsafe equipment.**

**WARNING: Never perform maintenance or service while lift is in use with a patient.**

## User Inspections

Action/check	Initially	Before every use	Every 2 months	Every 4 months	Every year	Every 2 years
<b>Lift device</b>						
Inspect for missing hardware or broken enclosure.	X	X			X	
Inspect strap for wear.		X	X			
Inspect if pass-through hook has any damage (seems loose or you notice cracks).		X				
Recharging batteries.		X				
Inspect the folding sling supports on the strap of the lift for damage or cracks.					X	
Inspect wheels in rail for damage, rust or cracks. Replace if damaged.					X	
Clean the rail.				X		
Overall inspection by authorized personnel.					X	
<b>Sling and hardware</b>						
Check all sling attachments for sign of wear.		X				
Inspect sling material for wear or deterioration.		X				
Inspect sling straps for wear.		X				
Inspect for any defects or loose threads in the "stitched areas".		X				
Clean sling as indicated on the tag.	when necessary					
Verify emergency stop button.				X		
Verify emergency lowering device.				X		

# Care and Maintenance

## Inspections by an Authorized Service Technician

Action/check	Initially	Before every use	Every 2 months	Every 4 months	Every year	Every 2 years
Replace strap.						X
Inspect the welding aspect on the frame to detect cracks.					X	
Inspect transmission.					X	
Inspect connecting joints for proper attachment.					X	
Verify that the emergency brake on the drum is turning freely.					X	
Verify emergency devices for good functioning.					X	
Load test with SWL (maximum working capacity).					X	

**WARNING: Always reinstall the rail end stoppers (if removed) after servicing. These stoppers are part of safety feature. Not having them in place can cause the trolley to fall off the rail and a patient fall.**

**WARNING: Make sure the trolley is compatible with the stoppers and rail system.**

# Care and Maintenance

## Daily Checklist

The following procedures must be followed before each use:

- Charge the batteries. Connect the lift to the charger whenever the lift is not in use.
- Inspect the lift for any damage. If the lift casing does not look properly aligned, or there are any cracks or other damage on the lift, or there are parts missing, DO NOT USE IT. Contact your Arjo agent to have the lift serviced.
- Inspect the strap for any visible signs of wear, frays, loose threads or other damage (see ). If there is any evidence of damage, DO NOT USE IT. Contact your local Arjo agent to have the lift serviced.
- Inspect the sling for tears, frayed straps or loose stitching. If the sling has any of the above damage, DO NOT USE IT. Contact your local Arjo agent to have the sling replaced or repaired.
- Inspect the folding supports for any signs of cracking or damage. Inspect the carabiner at the top of the strap to ensure that it is properly attached.

## Cleaning

### Removing visible residues:

- 1) Use a cloth soaked with water.
- 2) Remove visible residues located on the *Maxi Sky 440*. Start from top and move downwards.

### Cleaning:

- 1) Use a damp cloth with warm water mixed with a mild detergent.
- 2) Scrub the equipment from top to bottom, removing all visible residues.
- 3) Rinse with clean water any remaining residual detergent. Then wipe clean with a dry cloth.

**NOTE: Pay special attention to areas pointed below. These are most likely to enclose germs. Use a smaller brush and/or cotton swab to reach them.**

## Maxi Sky 440's Special Areas to Clean

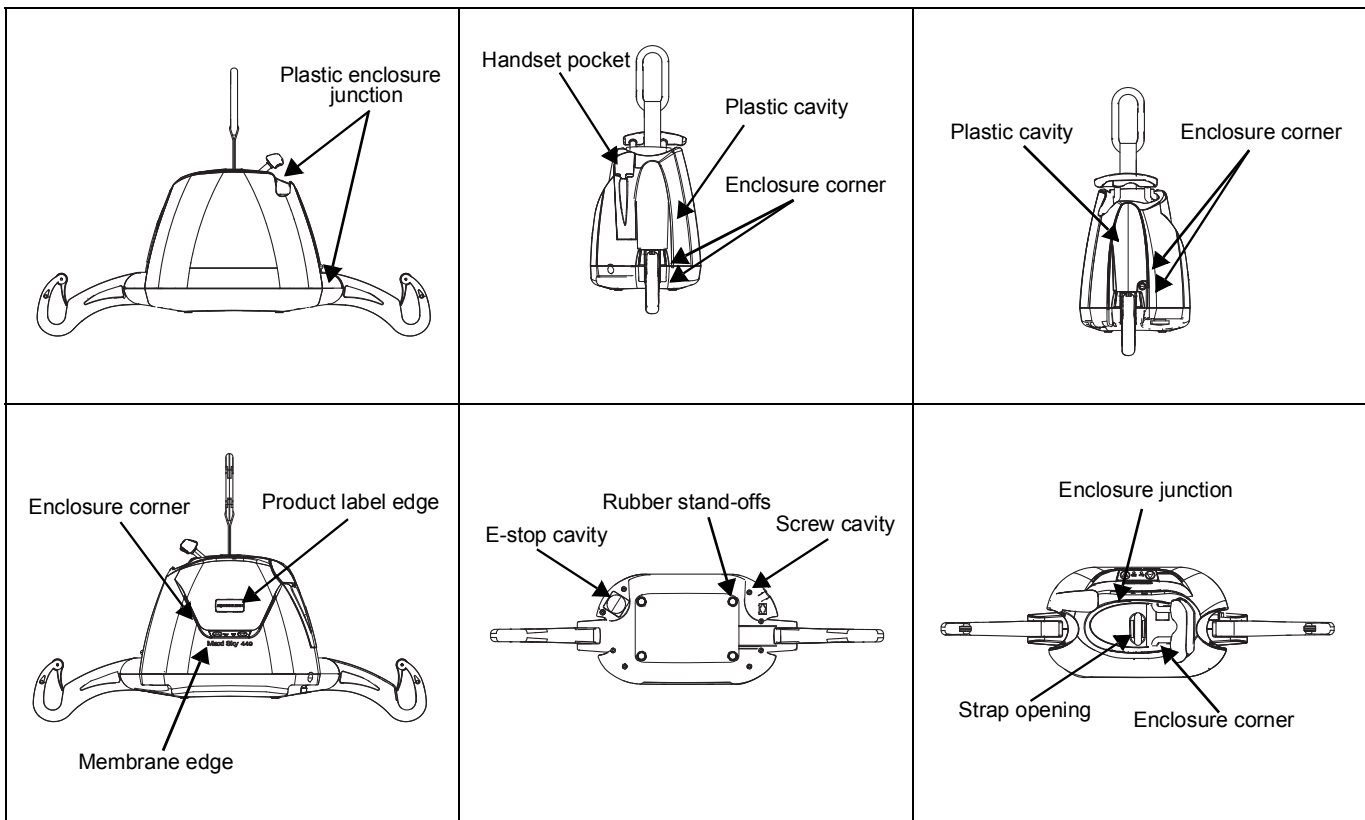

Fig. 15

# Care and Maintenance

Disinfectant wipes, supplied already impregnated with a 70% v/v solution of isopropyl alcohol, can also be used.

Rub the lift vigorously when using the wipes, to promote an effective disinfection of its entire surface. Do not use phenol, chlorine or any other type of solvent that may damage the finish.

**NOTE: The lift and the sling should be cleaned between use of different patients and/or when suspected to be contaminated.**

**CAUTION: Do not splash, drench or immerse the unit in water. The lift is an electrical device and water could damage your unit.**

To ensure a better rolling surface for the trolley wheels, clean the inside of the rail every 4 months. To do so, insert a damp cloth in the opening and slide it from one end of the rail to the other.

## Strap Inspection

If the strap is damaged or shows signs of wear or discoloration, the acceptable load on the strap before rupture can drop rapidly and present a danger for the patient or caregiver. Arjo recommends a thorough inspection of the straps every 2 months as follows:

- 1) Completely unwind the strap.
- 2) Look for any signs of wear or discoloration (see below).

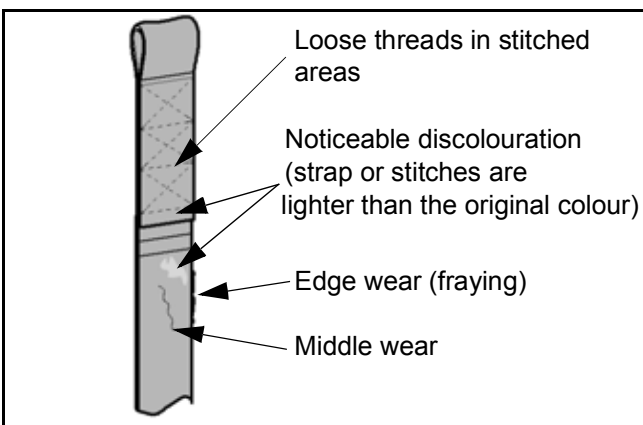

Fig. 16

**WARNING: If there is any sign of wear as indicated above or any other visual defects, the strap must be inspected by qualified personnel and changed if required.**

**The manufacturer recommends changing the strap at least every 2 years or every 2850 cycles—which ever comes first.**

**By continuing to use the lift without changing a damaged strap, the safety of the caregiver or patient is greatly compromised.**

## Handling and Storage

Avoid violent impacts while transporting the lift.

The lift should not remain stored for long periods of time without recharging the batteries.

**NOTE: Even if the lift is not used, Arjo recommends charging the batteries at least every 2 weeks. This will prevent premature aging of batteries.**

If you store or ship the *Maxi Sky 440*, ensure that the power is turned off (emergency button pushed in) beforehand.

## Battery Replacement

Replace the batteries when there is a noticeable reduction in the number of transfers that can be done between charges. If you hear the *Maxi Sky 440* beeping, see the instructions in the “Troubleshooting” section to determine if there is a problem with the batteries.

For battery replacement, contact your local Arjo agent.

**CAUTION: Do not attempt to use batteries that were not supplied by Arjo. These batteries are specially designed for Arjo charging systems. Attempting to use unapproved batteries may seriously damage the lift and/or the charger.**

## Verification of the Charger’s Power Source

If the light does not illuminate when there are batteries correctly installed in the *Maxi Sky 440*, try the following:

- 1) Make sure that the charger is correctly plugged into the AC outlet.
- 2) Make sure that the charger connector is properly connected to the unit.

# Care and Maintenance

---

- 3) Check the power of the AC outlet on the wall.
- 4) If the charger indicator (yellow) does not light up, contact your local Arjo agent for assistance.

## Sling Inspection and Care

See the documentation that comes with the sling.

## Annual Inspection

The *Maxi Sky 440* must be inspected annually by a qualified technician.

**WARNING:** The *Maxi Sky 440* and accessories must be serviced every 12 months as a minimum requirement. Moving parts can be affected by wear. Not servicing the product may lead to patient fall, causing injuries. Do not attempt to do the inspection.

## Maintenance Requirements

The *Maxi Sky 440* is equipped with an electronic monitor that causes a red light to flash when a maintenance inspection is necessary. Arranging for scheduled inspections ensures the durability of the unit and the security of both patient and user.

Once that red light begins to flash, please contact your local Arjo agent in order to perform the necessary maintenance inspection.



# Troubleshooting

**WARNING: Do not attempt to open the *Maxi Sky 440* portable lift cassette. Only a qualified technician is authorized to open it. Alterations made to the portable lift by someone other than a qualified technician may cause serious injury.**

Problem	To check
The red “service” light is on and flashing.	<ul style="list-style-type: none"> <li>Contact your local Arjo agent for maintenance.</li> </ul>
The unit starts and stops repetitively.	<ul style="list-style-type: none"> <li>If the load is greater than the unit’s safe working load, it will not function due to an overload protection on the motor.</li> <li>Batteries are low and need to be changed. Contact your local Arjo agent.</li> </ul>
The lift emits a “beep” during use. The unit may stop lifting the patient but can still lower the patient.	<ul style="list-style-type: none"> <li>Batteries are low and need to be recharged.</li> </ul>
Charger indicator on the lift (yellow) does not light up when the charger is connected to the lift.	<ul style="list-style-type: none"> <li>Check that the charger is plugged into a standard electrical outlet, and that the outlet has power.</li> </ul>
The lift does not work when you press the buttons on the hand control.	<ul style="list-style-type: none"> <li>If the emergency stop is activated, gently release the emergency button.</li> <li>Check if the buttons on the lift are working. If they are working, the problem may come from the hand control. If they are not working, check the charge on the lift.</li> <li>Check to see if the hand control is plugged in properly into the lift. The hand control may be slightly pulled out from its socket and yet appear as though it is plugged in. Check the connection.</li> <li>If, after testing all of the above, the lift will not operate, contact your Arjo agent.</li> </ul>

# Labels on the Lift

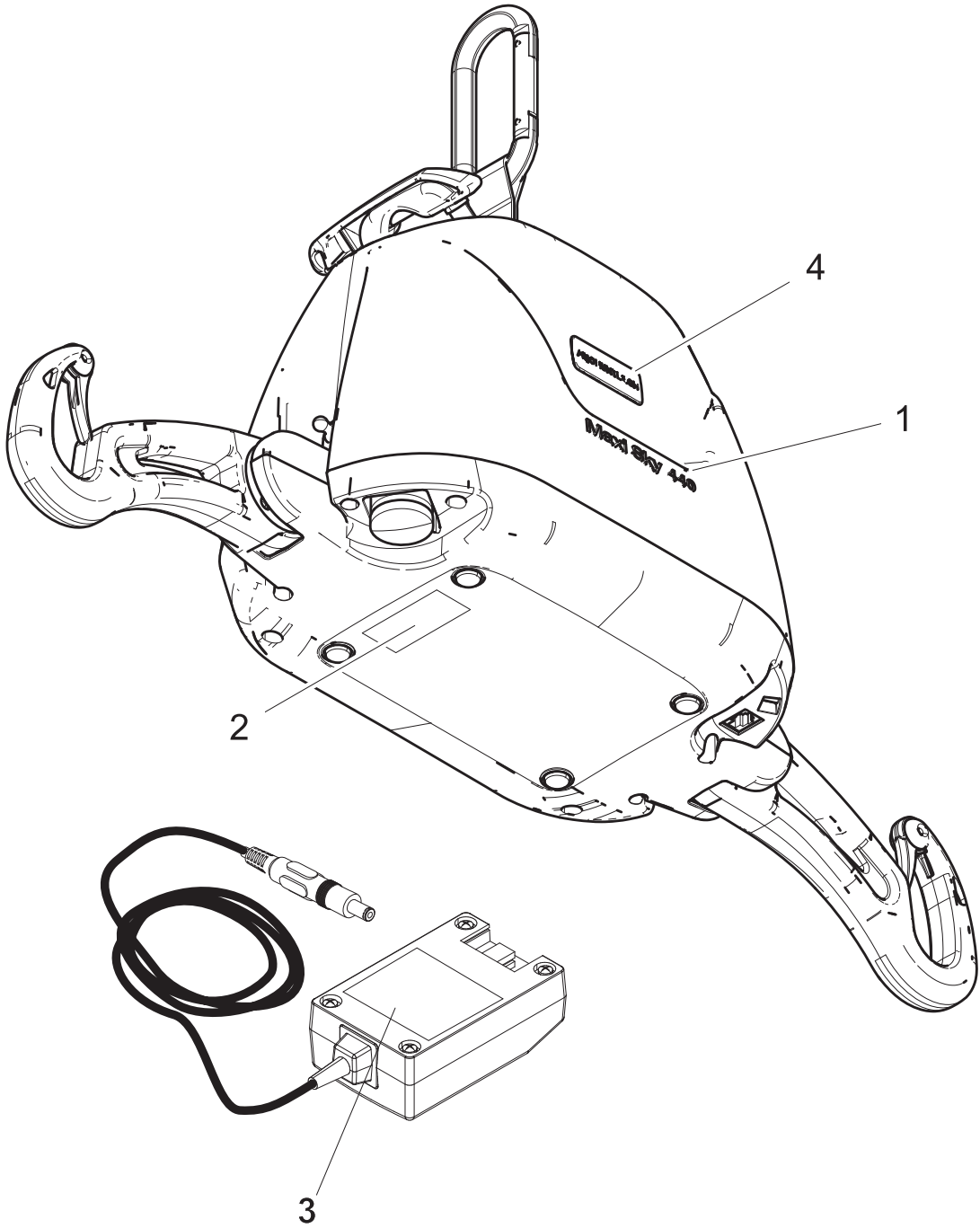

- 1) Product name
- 2) Serial number label
- 3) Charger information
- 4) Logo sticker

Fig. 17

# Technical Specifications

<b>PRODUCT INFORMATION</b>	
Weight, complete	6.5 kg (14.3 lb)
Lifting capacity (SWL)	200 kg (440 lb)
Strap length	2200 mm (88 in)
Lifting speed	4.3 cm/s (1.7 in/s)
Operating Force of Control	< 5 N (Installed unit)
<b>ELECTRICAL</b>	
Duty cycle	Max 10%, 6 min/hr, (max. 1 min. continuous)
Rating	24 VDC, 10 A max.
Noise level for either raising or lowering, with or without load	54 dBAm <sub>ax</sub> .
Medical equipment	Type BF protection against electrical shock in accordance with IEC 60601-1
Maxi Sky 440 is compliant to the IEC 60601-1 series including applicable collateral standards and national deviations. Maxi Sky 440 is compliant to the ISO 10535 standard.	
<b>WARNING: Portable RF communications equipment (including peripherals such as antenna cables &amp; external antennas) should be used no closer than 30 cm to any part of the Maxi Sky 440, including cables specified by the manufacturer. Otherwise, performance degradation of this equipment could result. See the “Electromagnetic Compatibility” section for more details.</b>	
<b>BATTERIES AND CHARGER UNIT</b>	
Batteries	Qty: 2 x rechargeable 12 VDC, 2.3 Ah
Battery capacity	Provides up to 30 transfers with a load of 80 kg (176 lb)
Degree of protection - Hand Control	IPX7
Degree of protection - Maxi Sky 440	IP21
Lift - protection class - shock prevention	Internally powered equipment
Battery Charger input	100-240 VAC, 50-60 Hz, 50 VA
Battery Charger output	24 VDC, 24 VA, 28.1 Vdc, 1 A
Battery Charger safety protection	Class 2, double insulated
<b>OPERATION CONDITIONS</b>	
Ambient temperature range	+5 °C to +40 °C (+41 °F to +104 °F)
Relative humidity range	15 % to 93 %, non-condensing
Atmospheric pressure range	700 hPa to 1060 hPa (max. 2000 m)
<b>STORAGE CONDITIONS</b>	
Ambient temperature range	-25 °C to +70 °C (-13 °F to +158 °F)
Relative humidity range	Up to 93 %, non-condensing
Atmospheric pressure range	500 hPa to 1060 hPa
<b>WARNING: This equipment is not suitable in the presence of flammable anesthetic mixtures with air or oxygen, or with nitrous oxide. Using the Maxi Sky 440 in this environment might lead to an explosion. The lift might create some spark internally and ignite the gaz.</b>	
<b>SAFE DISPOSAL AT END OF LIFE</b>	
Package	Corrugated cardboard, recyclable. Expanded polystyrene (EPS), recyclable.
Electrical and Electronic Components	Lift systems having electrical and electronic components or an electrical cord should be disassembled and recycled per Waste of Electrical and Electronic Equipment (WEEE) or in accordance with local or national regulation.
Slings	Slings including stiffeners/ stabilizers, padding material, any other textiles or polymers or plastic materials etc. should be sorted as combustible waste.

# Technical Specifications

Batteries	Seal lead-acid, rechargeable, recyclable. All batteries in the product must be recycled separately. Batteries are to be disposed in accordance with national or local regulations.
The lift	Separate and recycled. Components that are primarily be made up of different kinds of metal (containing more than 90% metal by weight) for example trolleys, sling bars, rails, upright supports, etc., should be recycled as metals.

## Lift Dimensions

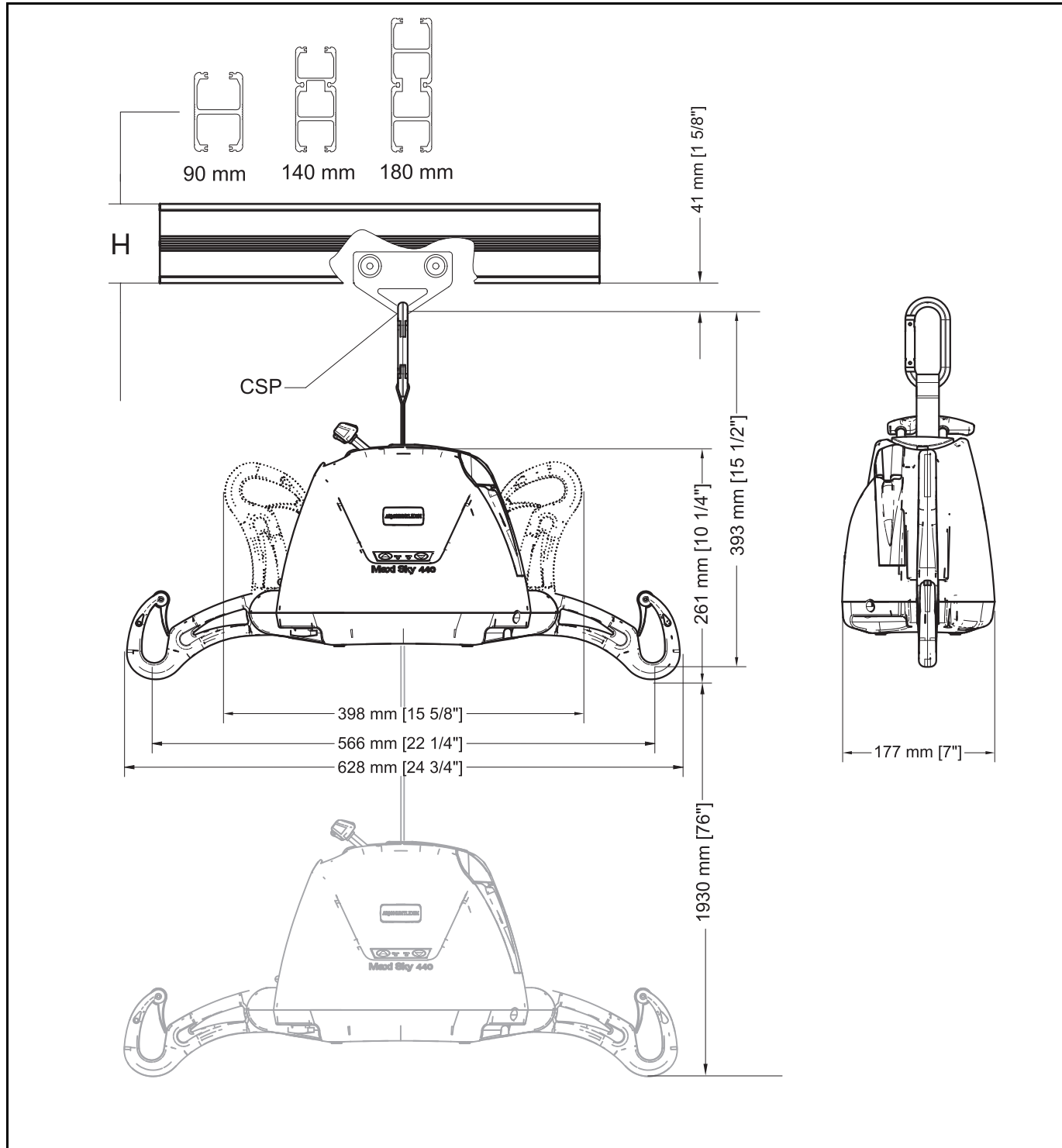

Fig. 18

# Electromagnetic Compatibility

**WARNING: Refer to the addendum provided with the adapted trolley for rail systems other than KWIKtrak.**

## Electromagnetic Compliance

The Maxi Sky 440 has been tested for compliance with current regulatory standards regarding its capacity to block EMI (electromagnetic interference) from external sources.

Nonetheless, some procedures can help reduce electromagnetic interferences:

- Ensure that other devices in patient-monitoring and/or life-support areas comply to accepted emissions standards.
- Maximize the distance between electro-medical devices. High-powered devices may produce EMI that can affect the ceiling lift.

For more information on how to manage the unit's RF electromagnetic environment, please consult the *AMI TIR 18-1997 - Guidance on Electromagnetic Compatibility of Medical Devices for Clinical/Biomedical Engineers*.

**WARNING: Use of accessories, cables and spare parts other than those specified or provided by Arjo could result in increased electromagnetic emissions or decreased electromagnetic immunity of this equipment and result in improper operation.**

**WARNING: Use of this equipment adjacent to or stacked with other equipment should be avoided because it could result in improper operation. If such use is necessary, this equipment and the other equipment should be observed to verify that they are operating normally.**

**WARNING: The equipment may cause radio interference or may disrupt the operation of nearby equipment. It may be necessary to take action, such as reorienting, relocating the equipment or shielding the location.**

## Electromagnetic Emissions

### Guidance and Manufacturer's Declaration - Electromagnetic Emissions - For all Equipment and Systems

The Maxi Sky 440 is intended for use in the electromagnetic environment indicated below. The customer or the user of the Maxi Sky 440 should assure that it is used in such an environment.

Emissions test	Compliance	Electromagnetic environment - guidance
RF emissions CISPR 11	Group 1	The Maxi Sky 440 is suitable for use in all establishments, including domestic establishments and those directly connected to the public low-voltage power supply network that supplies buildings used for domestic purposes.
RF emissions CISPR 11	Class B	
Harmonic emissions IEC 61000-3-2	Class A	
Voltage fluctuations/flicker emissions IEC 61000-3-3	Complies	

# Electromagnetic Compatibility

## Electromagnetic Immunity

Guidance and Manufacturer's Declaration - Electromagnetic Immunity - For all Equipment and Systems			
The Maxi Sky 440 is intended for use in electromagnetic environment specified below. The customer or the user of the Maxi Sky 440 should assure that it is used in such an environment.			
Immunity test	IEC 60601 test level	Compliance level	Electromagnetic environment - guidance
Electrostatic discharge (ESD)  IEC 61000-4-2	±8 kV contact ±15 kV air	±8 kV contact ±15 kV air	Floors should be wood, concrete or ceramic tile. If floors are covered with synthetic material, the relative humidity should be at least 30%.
Electrical fast transient/burst  IEC 61000-4-4	±2 kV, AC Mains ±1 kV, I/O Ports  100 kHz repetition frequency	±2 kV, AC Mains ±1 kV, I/O Ports  100 kHz repetition frequency	Mains power quality should be that of a typical commercial or hospital environment.
Surge  IEC 61000-4-5	±2 kV, AC Mains, Line to Ground  ±1 kV, AC Mains, Line to Line	±2 kV, AC Mains, Line to Ground  ±1 kV, AC Mains, Line to Line	Mains power quality should be that of a typical commercial or hospital environment.
Voltage dips, short interruptions and voltage variations on power supply input lines  IEC 61000-4-11	0 % $U_T$ ; 0,5 cycle At 0°, 45°, 90°, 135°, 180°, 225°, 270° and 315°  0 % $U_T$ ; 1 cycle and 70 % $U_T$ ; 25/30 cycle Single phase: at 0°  0 % $U_T$ ; 250/300 cycle	0 % $U_T$ ; 0,5 cycle At 0°, 45°, 90°, 135°, 180°, 225°, 270° and 315°  0 % $U_T$ ; 1 cycle and 70 % $U_T$ ; 25/30 cycle Single phase: at 0°  0 % $U_T$ ; 250/300 cycle	Mains power quality should be that of a typical commercial or hospital environment.
Power frequency (50/60 Hz) magnetic field  IEC 61000-4-8	30 A/m  50/60 Hz	30 A/m  50/60 Hz	Power frequency magnetic fields should be at levels characteristic of a typical location in a typical commercial or hospital environment.
NOTE: $U_T$ is the AC mains voltage prior to application of the test level.			

# Electromagnetic Compatibility

(continued)

Guidance and Manufacturer's Declaration - Electromagnetic Immunity - For all Equipment and Systems			
Immunity test	IEC 60601 test level	Compliance level	Electromagnetic environment - guidance
Conducted RF IEC 61000-4-6	3 V outside ISM bands between 0.15-80 MHz  6 V inside ISM and amateur radio bands between 0.15- 80 MHz	3 V outside ISM bands between 0.15-80 MHz  6 V inside ISM and amateur radio bands between 0.15- 80 MHz	N/A
Radiated RF IEC 61000-4-3	10 V/m 80 MHz to 2.7 GHz	10 V/m 80 MHz to 2.7 GHz	N/A
Proximity fields from RF wireless communications equipment IEC 61000-4-3	380 - 390 MHz 27 V/m; PM 50 %; 18 MHz  430 - 470 MHz 28 V/m; (FM $\pm 5$ kHz, 1 kHz sine) PM; 18 Hz  800 - 960 MHz 28 V/m; PM 50 %; 18 Hz  1700 - 1990 MHz 28 V/m; PM 50 %; 217 Hz  2400 - 2570 MHz 28 V/m; PM 50 %; 217 Hz  5100 - 5800 MHz 9 V/m; PM 50 %; 217 Hz  704 - 787 MHz 9 V/m; PM 50 %; 217 Hz	380 - 390 MHz 27 V/m; PM 50 %; 18 MHz  430 - 470 MHz 28 V/m; (FM $\pm 5$ kHz, 1 kHz sine) PM; 18 Hz  800 - 960 MHz 28 V/m; PM 50 %; 18 Hz  1700 - 1990 MHz 28 V/m; PM 50 %; 217 Hz  2400 - 2570 MHz 28 V/m; PM 50 %; 217 Hz  5100 - 5800 MHz 9 V/m; PM 50 %; 217 Hz  704 - 787 MHz 9 V/m; PM 50 %; 217 Hz	N/A

Intentionally left blank



Intentionally left blank

Intentionally left blank

**AUSTRALIA**

Arjo Australia  
 Building B, Level 3  
 11 Talavera Road  
 Macquarie Park, NSW, 2113, Australia  
 Phone: 1800 072 040

**BELGIQUE / BELGIË**

Arjo Belgium nv  
 Evenbroekveld 16  
 9420 Erpe-Mere  
 Belgium  
 T: +32 (0) 53 60 73 80  
 F: +32 (0) 53 60 73 81  
 E-mail: info.belgium@arjo.com

**BRASIL**

Arjo Brasil Equipamentos Médicos Ltda  
 Rua Marina Ciufulli Zanfelice, 329 PB02 Galpão  
 - Lapa  
 São Paulo – SP – Brasil  
 CEP: 05040-000  
 Phone: 55-11-3588-5088  
 E-mail: vendas.latam@arjo.com  
 E-mail: servicios.latam@arjo.com

**CANADA**

Arjo Canada Inc.  
 90 Matheson Boulevard West  
 Suite 300  
 CA-MISSISSAUGA, ON, L5R 3R3  
 Tel/Tél: +1 905 238 7880  
 Free: +1 800 665 4831 Institutional  
 Free: +1 800 868 0441 Home Care  
 Fax: +1 905 238 7881  
 E-mail: info.canada@arjo.com

**ČESKÁ REPUBLIKA**

Arjo Czech Republic s.r.o.  
 Na Strži 1702/65  
 140 00 Praha  
 Czech Republic  
 Phone No: +420225092307  
 e-mail: info.cz@arjo.com

**DANMARK**

Arjo A/S  
 Vassingerødvej 52  
 DK-3540 LYNØ  
 Tel: +45 49 13 84 86  
 Fax: +45 49 13 84 87  
 E-mail:  
 dk\_kundeservice@arjo.com

**DEUTSCHLAND**

Arjo GmbH  
 Peter-Sander-Strasse 10  
 DE-55252 MAINZ-KASTEL  
 Tel: +49 (0) 6134 186 0  
 Fax: +49 (0) 6134 186 160  
 E-mail: info-de@arjo.com

**ESPAÑA**

Arjo Ibérica S.L.  
 Parque Empresarial Rivas Futura, C/Marie Curie 5  
 Edificio Alfa Planta 6 oficina 6.1-62  
 ES-28521 Rivas Vacia, MADRID  
 Tel: +34 93 583 11 20  
 Fax: +34 93 583 11 22  
 E-mail: info.es@arjo.com

**FRANCE**

Arjo SAS  
 2 Avenue Alcide de Gasperi  
 CS 70133  
 FR-59436 RONCQ CEDEX  
 Tél: +33 (0) 3 20 28 13 13  
 Fax: +33 (0) 3 20 28 13 14  
 E-mail: info.france@arjo.com

**HONG KONG**

Arjo Hong Kong Limited  
 Room 411-414, 4/F,  
 Manhattan Centre,  
 8 Kwai Cheong Road,  
 Kwai Chung, N.T.,  
 HONG KONG  
 Tel: +852 2960 7600  
 Fax: +852 2960 1711

**ITALIA**

Arjo Italia S.p.A.  
 Via Giacomo Peroni 400-402  
 IT-00131 ROMA  
 Tel: +39 (0) 6 87426211  
 Fax: +39 (0) 6 87426222  
 E-mail: Italy.promo@arjo.com

**MIDDLE EAST**

Arjo Middle East FZ-LLC  
 Office 908, 9th Floor,  
 HQ Building, North Tower,  
 Dubai Science Park,  
 Al Barsha South  
 P.O Box 11488, Dubai,  
 United Arab Emirates  
 Direct +971 487 48053  
 Fax +971 487 48072  
 Email: Info.ME@arjo.com

**NEDERLAND**

Arjo BV  
 Biezenwei 21  
 4004 MB TIEL  
 Postbus 6116  
 4000 HC TIEL  
 Tel: +31 (0) 344 64 08 00  
 Fax: +31 (0) 344 64 08 85  
 E-mail: info.nl@arjo.com

**NEW ZEALAND**

Arjo Ltd  
 34 Vestey Drive  
 Mount Wellington  
 NZ-AUCKLAND 1060  
 Tel: +64 (0) 9 573 5344  
 Free Call: 0800 000 151  
 Fax: +64 (0) 9 573 5384  
 E-mail: nz.info@Arjo.com

**NORGE**

Arjo Norway AS  
 Olaf Helsets vei 5  
 N-0694 OSLO  
 Tel: +47 22 08 00 50  
 Faks: +47 22 08 00 51  
 E-mail: no.kundeservice@arjo.com

**ÖSTERREICH**

Arjo GmbH  
 Lemböckgasse 49 / Stiege A / 4.OG  
 A-1230 Wien  
 Tel: +43 1 8 66 56  
 Fax: +43 1 866 56 7000

**POLSKA**

Arjo Polska Sp. z o.o.  
 ul. Ks Piotra Wawrzyniaka 2  
 PL-62-052 KOMORNIKI (Poznań)  
 Tel: +48 61 662 15 50  
 Fax: +48 61 662 15 90  
 E-mail: arjo@arjo.com

**PORTUGAL**

Arjo em Portugal  
 MAQUET Portugal, Lda.  
 (Distribuidor Exclusivo)  
 Rua Poeta Bocage n.º 2 - 2G  
 PT-1600-233 Lisboa  
 Tel: +351 214 189 815  
 Fax: +351 214 177 413  
 E-mail: Portugal@arjo.com

**SUISSE / SCHWEIZ**

Arjo AG  
 Fabrikstrasse 8  
 Postfach  
 CH-4614 HÄGENDORF  
 Tél/Tel: +41 (0) 61 337 97 77  
 Fax: +41 (0) 61 311 97 42

**SUOMI**

Arjo Scandinavia AB  
 Riihitontuntie 7 C  
 02200 Espoo  
 Finland  
 Puh: +358 9 6824 1260  
 E-mail:  
 Asiakaspalvelu.finland@arjo.com

**SVERIGE**

Arjo International HQ  
 Hans Michelsensgatan 10  
 SE-211 20 MALMÖ  
 Tel: +46 (0) 10 494 7760  
 Fax: +46 (0) 10 494 7761  
 E-mail: kundservice@arjo.com

**UNITED KINGDOM**

Arjo UK and Ireland  
 Houghton Hall Park  
 Houghton Regis  
 UK-DUNSTABLE LU5 5XF  
 Tel: +44 (0) 1582 745 700  
 Fax: +44 (0) 1582 745 745  
 E-mail: sales.admin@arjo.com

**USA**

Arjo Inc.  
 2349 W Lake Street Suite 250  
 US-Addison, IL 60101  
 Tel: +1 630 307 2756  
 Free: +1 800 323 1245 Institutional  
 Free: +1 800 868 0441 Home Care  
 Fax: +1 630 307 6195  
 E-mail: us.info@arjo.com

**JAPAN**

Arjo Japan K.K.  
 東京都港区虎ノ門三丁目7番8号 ランディック第  
 2虎ノ門ビル9階  
 電話 : +81 (0)3-6435-6401

Address page - REV 25: 01/2020

At Arjo, we are committed to improving the everyday lives of people affected by reduced mobility and age-related health challenges. With products and solutions that ensure ergonomic patient handling, personal hygiene, disinfection, diagnostics, and the effective prevention of pressure ulcers and venous thromboembolism, we help professionals across care environments to continually raise the standard of safe and dignified care. Everything we do, we do with people in mind.



ArjoHuntleigh AB  
Hans Michelsensgatan 10  
211 20 Malmö, Sweden  
[www.arjo.com](http://www.arjo.com)

**arjo**



001.16000.33.EN

