



# PATIENT LIFTERS & SLINGS

Mobile patient lifters & slings designed for a range of environments, from community to facility



# A150F ALUMINIUM FOLDING LIFTER

The Aidacare Aspire A150F is a lightweight and portable folding patient lifter designed for home and community environments.

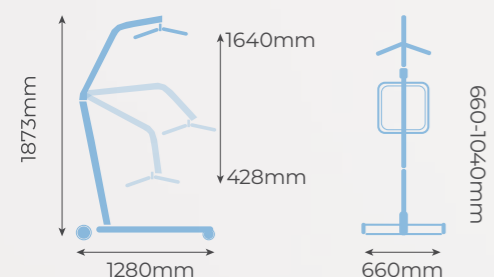

For detailed technical specifications see page 18



## FEATURES



### FOLDS FOR TRANSPORT AND STORAGE

Folds quickly and conveniently for storage or transport in the boot of the car.



### BUILD QUALITY

Strong powder coated aluminium frame with industry leading Linak electronics, Tente castors and warranty provision.



### OFFSET LEG DESIGN

Provides additional accessibility around chairs and furniture in the home.



### QUICK RELEASE YOKE ATTACHMENT

One touch release and attach mechanism, designed for the busy caregiver. Padded yoke for added patient safety



### INTELLIGENT DIAGNOSTICS

State of the art Linak Jumbo Care control system. Tracks usage and service requirements for safety and compliance.



### ERGONOMIC HANDSET

The latest slimline technology from Linak fits neatly in the hand with an intuitive control panel. Battery and service indicator lights assist with service scheduling



### LEG FUNCTION

Simple foot operation to open or close legs for lifting stability or accessibility.



### SAFETY

Critical features include emergency stop button, emergency lowering and anti-entrapment technology, with both patient and caregiver safety at heart

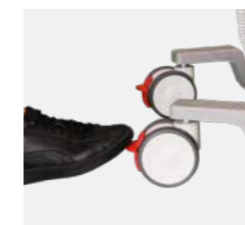

### TENTE

2 x 75mm front castors for maximum under bed clearance and accessibility.  
2 x 100mm rear locking castors for safety and manoeuvrability.

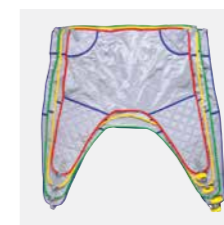

### SLING COMPATIBILITY

Compatible with a large range of Aspire Slings, as well as other brands.  
See page 20 for Full range of Aspire Slings

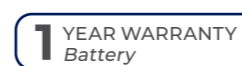
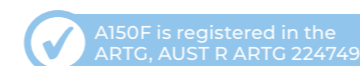

# A205 ALUMINIUM LIFTER

The Aidacare Aspire A205 is a compact and versatile aluminium mobile lifter with powered legs that is ideal for home, community and facility environments.

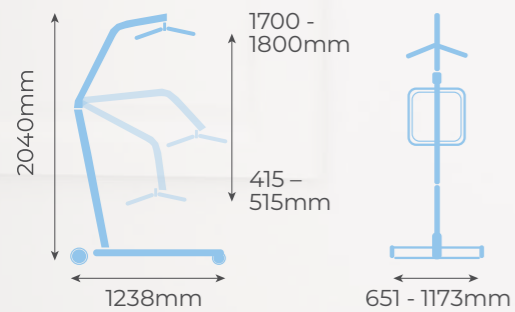

For detailed technical specifications see page 18



## FEATURES

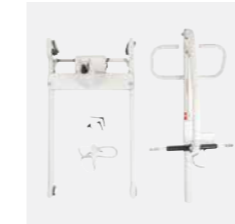

**TRANSPORT OR STORAGE**  
Is quick and convenient with tool free disassembly



**BUILD QUALITY**  
Strong powder coated aluminium frame with industry leading Linak electronics, Tente castors and warranty provision.



**ADJUSTABLE HEIGHT**  
Three adjustable height settings provides the caregiver with the flexibility to adjust the height range to suit the specific lift and patient scenario



**QUICK RELEASE YOKE ATTACHMENT**  
One touch release and attach mechanism, designed for the busy caregiver. Padded yoke for added patient safety.



**INTELLIGENT DIAGNOSTICS**  
State of the art Linak Jumbo Care control system. Tracks usage and service requirements for safety and compliance



**ERGONOMIC HANDSET**  
The latest slimline technology from Linak fits neatly in the hand with an intuitive control panel. Battery and service indicator lights assist with service scheduling



**POWERED LEG FUNCTION**  
Opens and closes the legs for lifting stability or accessibility



**SAFETY**  
Critical features include emergency stop button, emergency lowering and anti-entrapment technology, with both patient and caregiver safety at heart

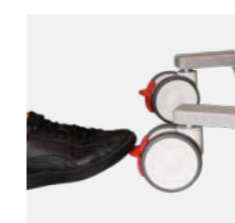

**TENTE**  
2 x 75mm front castors for maximum under bed clearance and accessibility.  
2 x 100mm rear locking castors for safety and manoeuvrability

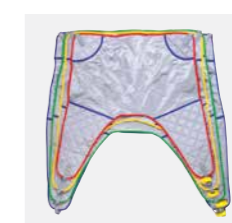

**SLING COMPATIBILITY**  
Compatible with a large range of Aspire Slings, as well as other brands.  
*See page 20 for Full range of Aspire Slings*

## DESIGN UPGRADED FOR INCREASED SWL

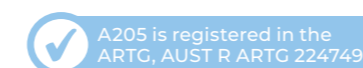

# 200 STEEL LIFTER

A robust workhorse, the Aidacare Aspire 200 is designed to meet the rigorous demands of professional and facility environments.

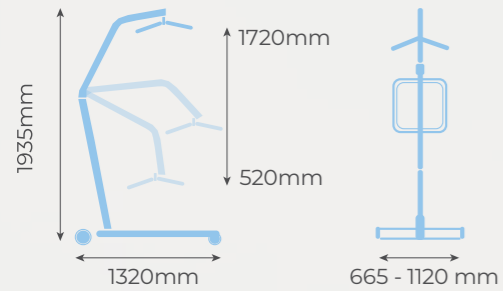

For detailed technical specifications see page 18



## FEATURES



### INTELLIGENT DIAGNOSTICS

State of the art Linak Jumbo Care control system. Tracks usage and service requirements for safety and compliance



### QUICK RELEASE YOKE ATTACHMENT

One touch release and attach mechanism, designed for the busy caregiver. Padded yoke for added patient safety



### ERGONOMIC HANDLES

Provide multiple grip points to suit carers of different heights and strengths



### ERGONOMIC HANDSET

The latest slimline technology from Linak fits neatly in the hand with an intuitive control panel. Battery and service indicator lights assist with service scheduling



### POWERED LEG FUNCTION

Opens and closes the legs for lifting stability or accessibility



### SAFETY

Critical features include emergency stop button, emergency lowering and anti-entrapment technology, with both patient and caregiver safety at heart

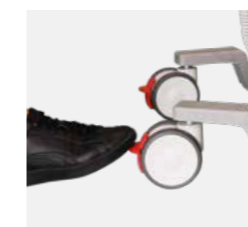

### TENTE

2 x 75mm front castors for maximum under bed clearance and accessibility.  
2 x 100mm rear locking castors for safety and manoeuvrability

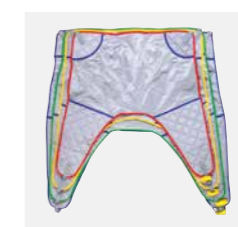

### SLING COMPATIBILITY

Compatible with a large range of Aspire Slings, as well as other brands.

See page 20 for Full range of Aspire Slings



### BUILD QUALITY

Strong powder coated aluminium frame with industry leading Linak electronics, Tente castors and warranty provision.

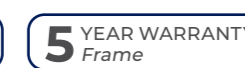
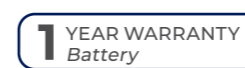
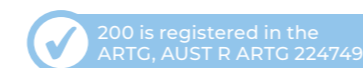

# A320 ALUMINIUM BARIATRIC LIFTER



The Aidacare Aspire A320 will exceed expectations even in the most demanding clinical environments. Its broad base and ample patient clearance compliments the substantial 320kg safe working load.

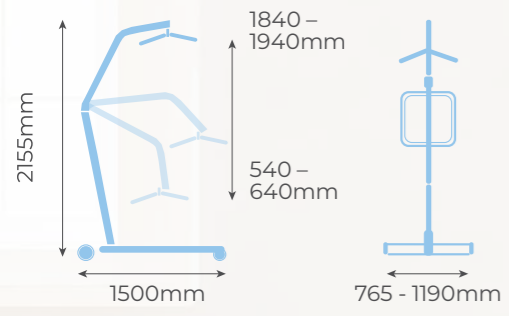

For detailed technical specifications see page 18

## FEATURES



### INTELLIGENT DIAGNOSTICS

State of the art Linak Jumbo Care control system. Tracks usage and service requirements for safety and compliance



### BUILD QUALITY

Strong powder coated aluminium frame with industry leading Linak electronics, Tente castors and warranty provision.



### ADJUSTABLE HEIGHT

Three adjustable height settings provides the caregiver with the flexibility to adjust the height range to suit the specific lift and patient scenario



### QUICK RELEASE 4 POINT YOKE

Padded 4 point yoke for added patient safety. One touch release and attach mechanism, designed for the busy caregiver

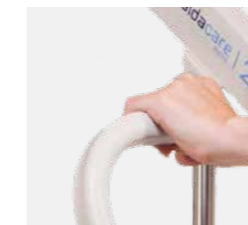

### ERGONOMIC HANDLES AND SUPPORT ARMS

Provide multiple grip points to suit carers of different heights and strengths. Folding support arms assist with stability or mobility but can also be folded out of the way



### ERGONOMIC HANDSET

The latest slimline technology from Linak fits neatly in the hand with an intuitive control panel. Battery and service indicator lights assist with service scheduling

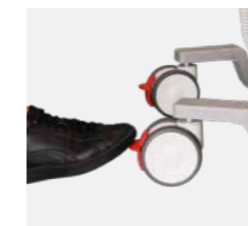

### TENTE

2 x 100mm front castors for reduced rolling resistance under high load.  
2 x 125mm rear locking castors for safety and manoeuvrability



### SAFETY

Critical features include emergency stop button, emergency lowering and anti-entrapment technology, with both patient and caregiver safety at heart



### POWERED LEG FUNCTION

Opens and closes the legs for lifting stability or accessibility

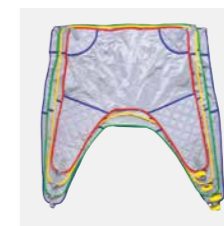

### SLING COMPATIBILITY

Compatible with a large range of Aspire Slings, as well as other brands.

See page 20 for Full range of Aspire Slings

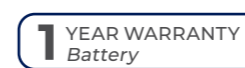
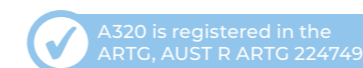

# A200S ALUMINIUM PATIENT STANDER

The Aidacare Aspire A200S is a compact, lightweight and manoeuvrable standing lifter ideal for home, community and facility environments.

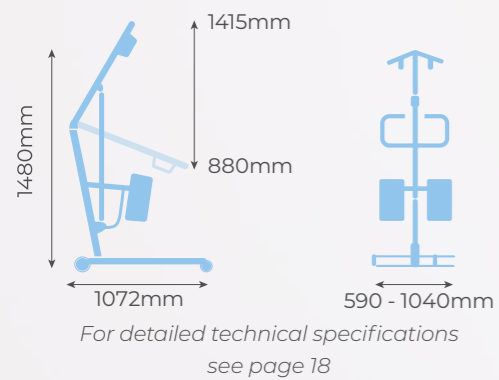

## FEATURES



### INTELLIGENT DIAGNOSTICS

State of the art Linak Jumbo Care control system. Tracks usage and service requirements for safety and compliance



### BUILD QUALITY

Strong powder coated aluminium frame with industry leading Linak electronics, Tente castors and warranty provision.



### ADJUSTABLE PADDED LEGRESTS

Provide comfort and support during transfers and can be adjusted to suit the patient

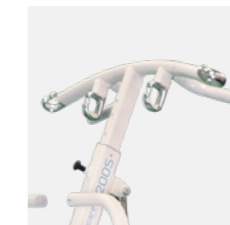

### ADJUSTABLE DEPTH YOKE

Yoke is depth adjustable for optimal patient fit



### ERGONOMIC HANDLES

Provide multiple grip points to suit carers of different heights and strengths



### ERGONOMIC HANDSET

The latest slimline technology from Linak fits neatly in the hand with an intuitive control panel. Battery and service indicator lights assist with service scheduling

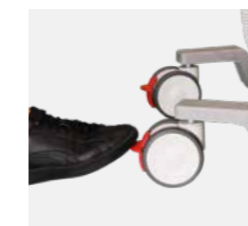

### TENTE

2 x 75mm front castors for maximum under bed clearance and accessibility.  
2 x 75mm rear locking castors for safety and manoeuvrability



### SAFETY

Critical features include emergency stop button, emergency lowering and anti-entrapment technology, with both patient and caregiver safety at heart



### POWERED LEG FUNCTION

Opens and closes the legs for lifting stability or accessibility

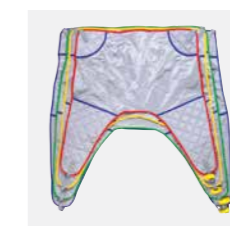

### SLING COMPATIBILITY

Compatible with a large range of Aspire Slings, as well as other brands.

See page 20 for Full range of Aspire Slings

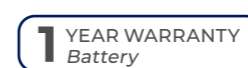
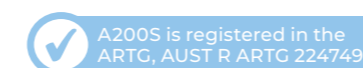

# 200S STEEL PATIENT STANDER

The Aidacare Aspire 200S is a robust and durable steel standing lifter capable in the most demanding facility environments.

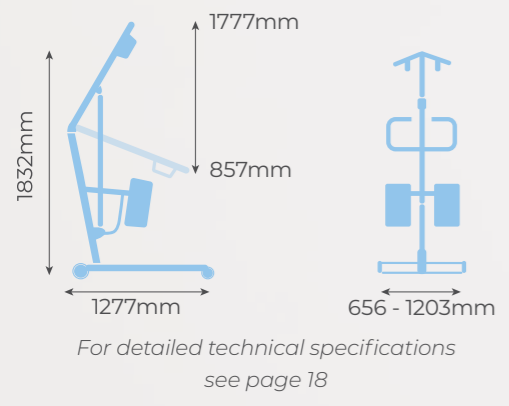

## FEATURES



### INTELLIGENT DIAGNOSTICS

State of the art Linak Jumbo Care control system. Tracks usage and service requirements for safety and compliance



### BUILD QUALITY

Strong powder coated aluminium frame with industry leading Linak electronics, Tente castors and warranty provision.



### ADJUSTABLE PADDED LEGRESTS

Provide comfort and support during transfers and can be adjusted to suit the patient

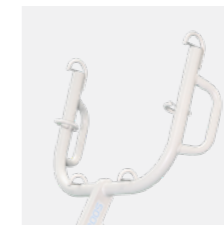

### BULLHORN LIFTING BOOM

Offset patient handles provide stability and 6 sling attachment points give the carer flexibility to perform the optimal lift in any scenario

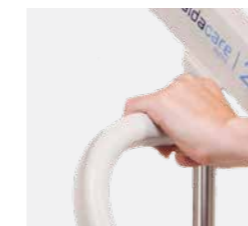

### ERGONOMIC HANDLES

Provide multiple grip points to suit carers of different heights and strengths



### ERGONOMIC HANDSET

The latest slimline technology from Linak fits neatly in the hand with an intuitive control panel. Battery and service indicator lights assist with service scheduling



### POWERED LEG FUNCTION

Opens and closes the legs for lifting stability or accessibility



### SAFETY

Critical features include emergency stop button, emergency lowering and anti-entrapment technology, with both patient and caregiver safety at heart

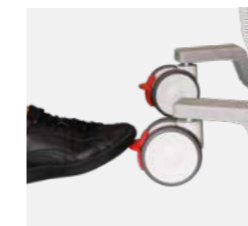

### TENTE

2 x 75mm front castors for maximum under bed clearance and accessibility.  
2 x 100mm rear locking castors for safety and manoeuvrability

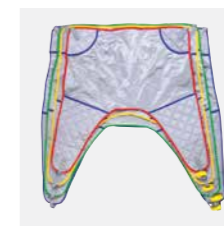

### SLING COMPATIBILITY

Compatible with a large range of Aspire Slings, as well as other brands.

See page 20 for Full range of Aspire Slings

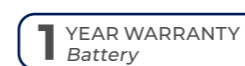
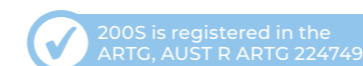

# STAR PATIENT MOVER



The Aspire Star Patient Mover (the Star Mover), provides a simple solution for transferring a user from a bed or chair in comfort and safety. Offering a compact and versatile design, the Star Mover is suitable for Homecare, Acute Care and Aged Care environments.



## FEATURES



### CLIP SLING ATTACHMENT POINTS

Allows a standing sling (optional accessory) with clips to be used for additional support where required

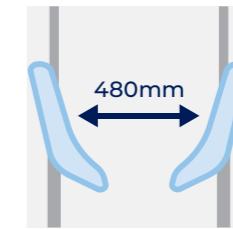

### WIDE SEAT ENTRY SPACE

Wide seat entry suits a larger range of body shapes

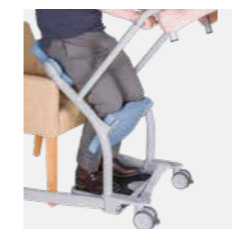

### FOUR USER CONTACT POINTS

The foot platform, knee pad, seat pads and grip handle promote stability, support and comfort for the user - resulting in greater confidence in the transfer



### SOFT TOUCH GRAB BAR

Soft touch grab bar provides a comfortable patient support for improved stability and confidence during transfers



### HEIGHT ADJUSTABLE SOFT KNEE PAD

Provides comfortable counter balance stability during transfers

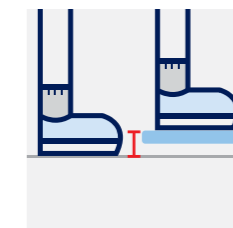

### LOW FOOTPLATE HEIGHT

Low footplate height makes patient entry and exit easier



### LOCKABLE 75MM CASTORS

The platform remains stationary while a user is transferring, while minimising the leg height for sufficient clearance beneath beds and furniture



### LARGE CASTERS

2x large 100mm locking TENTE castors

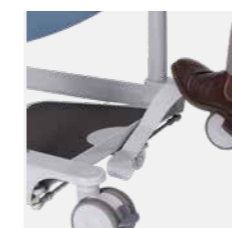

### WIDTH ADJUSTABLE LEGS

Activated via 2 foot pedals, provide the ability to manoeuvre closer to furniture, toilets or beds for safer access



### EASY TO CLEAN SURFACES

For effective and hassle-free infection control

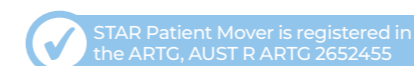

For detailed technical specifications see page 18



# INLINE WEIGHT SCALE



ADAPTABLE TO MOST OTHER LIFTER BRANDS

# MANUAL AND POWERED PIVOT FRAMES



## MANUAL

Assists with manual positioning and transfers of individual users.



## POWERED

Assists staff to conduct repetitive transfers in institutional care environments.

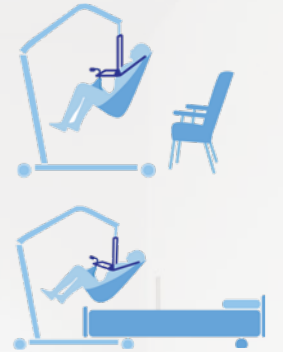

Effortlessly transition between sitting and lying down transfers.

## FEATURES



### ADAPTABLE TO MOST LIFTERS

Designed to be fitted on Aidacare Aspire Patient Lifters, however adaptable to most lifter brands.



### ACCURATE WEIGHT

Allows for an accurate weight measurement to be taken by a carer when a patient is suspended in a sling.



### WEIGHT CAPACITY

Large weight capacity of up to 320kg



### EASY TO READ

Easy to read LCD display.

## FEATURES



### SIMPLE USE WITH CLIP SLINGS

Designed for simplicity of attachment with clip slings.

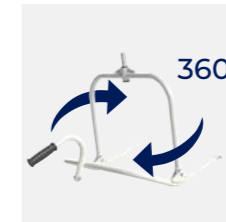

### ROTATING FRAME

Frame rotates in space for ease of sling attachment and patient positioning.



### INTEGRATED ELECTRONICS

Powered version seamlessly integrates with lifter control system for use with one handset.



### COMPATIBILITY

Compatible with a range of lifters.

### SUITS ASPIRE MODELS

A150F

Aluminium Folding Lifter  
See page 2 - 3

A205

Aluminium Patient Lifter  
See page 4 - 5

200

Steel Patient Lifter  
See page 6 - 7

A320

Aluminium Bariatric Lifter  
See page 8 - 9

### SUITS ASPIRE MODELS

A205

Aluminium Patient Lifter  
See page 4 - 5

200

Steel Patient Lifter  
See page 6 - 7

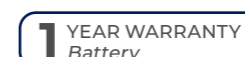
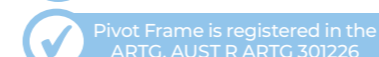
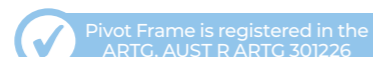

A320

Aluminium Bariatric Lifter  
See page 8 - 9



# TECHNICAL SPECIFICATIONS

## PATIENT LIFTER RANGE

	A150F	A205	200
			
Product Code	LSS390600	LSS390610	LSS390620
Safe Working Load (S.W.L)	150kg	205kg	200kg
Base Length	1280mm (1220mm folded)	1238mm	1320mm
External Base Width	660-1040mm (615mm folded)	651-1173mm	665-1120mm
Internal Base Width	580-950mm	547-1073mm	580-1040mm
Base Width Adjustment	Manual	Electric	Electric
Base Height Under Bed Clearance	133mm	110mm	110mm
Minimum Height of Spreader Bar **	428mm	415-515mm	520mm
Maximum Height of Spreader Bar**	1640mm	1700-1800mm	1720mm
Product Weight	32.9kg	38.1kg	40kg
Under Base Height	72mm	50mm	50mm
Maximum Overall Height	1873mm (395mm folded)	2040mm	1935mm
Front Castor Diameter	75mm	75mm	75mm
Rear Locking Castor Diameter	100mm	100mm	100mm
Turning Radius	1365mm	1332mm	1398mm
Weight Of Heaviest Part (Base Assembly)	32.9kg	19.6kg	23.0kg
Handle Height	1170mm	1085-1185mm	1220mm
Warranty - Frame	5 Years	5 Years	5 Years
Warranty - Electronics	3 Years	3 Years	3 Years
Warranty - Battery*	1 Year	1 Year	1 Year

### ACCESSORIES

Inline Weigh Scale (S.W.L 320kg) 	LSS390680	LSS390680	LSS390680
Manual Pivot Frame (S.W.L 227kg) 	LSS390670	LSS390670	LSS390670
Powered Pivot Frame (S.W.L 227kg) 	LSS390665	LSS390665	LSS390665
Leg Protectors	Not Available	GSP390815 (650mm x160mm)	GSP390815 (650mm x160mm) GSP390816 (750mm x 140mm)

\*Includes Battery Pack and Handset

\*\*Three mast height settings are possible hence the range of minimum and maximums

# TECHNICAL SPECIFICATIONS

A320	A200S	200S	STAR Patient Mover
			
LSS390630	LSS390640	LSS390650	LSS390580
320kg	200kg	200kg	185kg
1500mm	1070mm	1277mm	925mm
765-1190mm	590-1040mm	656-1203mm	520mm
640-1065mm	490-940mm	561-1103mm	740mm
Electric	Electric	Electric	Manual
155mm	110mm	110mm	60mm
540-640mm	880mm	857mm	-
1840-1940mm	1415mm	1777mm	-
63kg	33kg	40kg	40kg
155mm	50mm	50mm	-
2155mm	1480mm	1832mm	1030mm
100mm	75mm	75mm	100mm
125mm	75mm	100mm	100mm
1595mm	1160mm	1361mm	-
38.9kg	19kg	19.6kg	-
1200-1300mm	1160mm	1045mm	1030mm
5 Years	5 Years	5 Years	2 Years
3 Years	3 Years	3 Years	-
1 Year	1 Year	1 Year	-

LSS390680	Not Available	Not Available	Not Available
LSS390670	Not Available	Not Available	Not Available
LSS390665	Not Available	Not Available	Not Available
GSP390817 (750mm x 180mm)	GSP390815 (650mm x160mm)	Not Available	Not Available

To view our comprehensive list of spare parts visit [www.aidacarelifters.com.au](http://www.aidacarelifters.com.au)

# SLINGS

The Aidacare Aspire range of slings is designed to meet patient needs in the Home, Aged Care and Hospital environments.

Manufactured under the highest quality control standards, the extremely durable slings come in a range of fabrics and sizes to suit the individual patient and caregiver's needs.



SIZE	GIRTH	HEIGHT	SWL
<b>SMALL</b>	65 - 95cm	120 - 160cm	200kg
<b>MEDIUM</b>	77 - 110cm	140 - 175cm	200kg
<b>LARGE</b>	98 - 135cm	158 - 185cm	300kg
<b>X LARGE</b>	118 - 157cm	165 - 193cm	300kg
<b>XX LARGE</b>	155 - 184cm	170 - 193cm	300kg
<b>XXX LARGE</b>	180 - 210cm	170 - 193cm	300kg

## FEATURES



### DURABLE

Loop webbing has a breaking strain in excess of one tonne and is designed so that it will not tangle or "cork-screw" during cleaning



### QUALITY

Manufactured in the UK using European materials, computer guided stitching and CNC fabric cutting

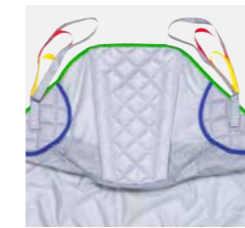

### PATIENT COMFORT

Additional padding in weight bearing areas.



### MANOEUVRING HANDLES

Thoughtfully positioned handles provide carers with a secure grip point to aid the transfer



### SERIAL NUMBERED / EMBROIDERED LABEL

Have embroidered labels and a unique serial number to maintain traceability and assist with compliance obligations.



### SERVICE AND MAINTENANCE

Service record labels ensure you can record and identify service history



### COLOUR CODED SIZING

All slings have reinforced edging that is colour coded for each size available – making them easy to identify



### PATIENT DIGNITY

Option to position strap around the outside of legs for more discreet positioning (applicable models)



### PATIENT SAFETY

Smart features such as velcro/ buckle combinations for more secure positioning and greater patient safety (applicable models)

## FABRICS

POLYESTER MESH

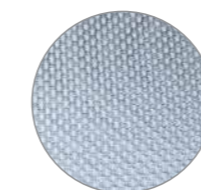

POLYESTER SOLID



SUPER SOFT

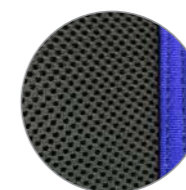

### EASY CLEAN

Machine washable up to 85°C

### WARRANTY

The Aspire sling range all come with a 12 month warranty

# SLINGS



## DELUXE GENERAL PURPOSE SLING

Code	Description	Edging	S.W.L
LSS390700	Deluxe General Purpose Sling - Polyester - Loop - Small	●	200kg
LSS390705	Deluxe General Purpose Sling - Polyester - Loop - Medium	●	200kg
LSS390710	Deluxe General Purpose Sling - Polyester - Loop - Large	●	300kg
LSS390715	Deluxe General Purpose Sling - Polyester - Loop - X-Large	●	300kg
LSS390716	Deluxe General Purpose Sling - Mesh - Loop - Small	●	200kg
LSS390717	Deluxe General Purpose Sling - Mesh - Loop - Medium	●	200kg
LSS390718	Deluxe General Purpose Sling - Mesh - Loop - Large	●	300kg
LSS390719	Deluxe General Purpose Sling - Mesh - Loop - X-Large	●	300kg

Deluxe General Purpose Sling is registered in the ARTG, AUST R ARTG 224718



## DELUXE HYGIENE ACCESS SLING WITH HEAD SUPPORT

Code	Description	Edging	S.W.L
LSS390780	Deluxe Hygiene Access Sling with Head Support - Polyester - Loop - Small	●	200kg
LSS390785	Deluxe Hygiene Access Sling with Head Support - Polyester - Loop - Medium	●	200kg
LSS390790	Deluxe Hygiene Access Sling with Head Support - Polyester - Loop - Large	●	300kg
LSS390795	Deluxe Hygiene Access Sling with Head Support - Polyester - Loop - X-Large	●	300kg
LSS390940	Deluxe Hygiene Access Sling with Head Support - Polyester - Clip - Small	●	200kg
LSS390945	Deluxe Hygiene Access Sling with Head Support - Polyester - Clip - Medium	●	200kg
LSS390950	Deluxe Hygiene Access Sling with Head Support - Polyester - Clip - Large	●	300kg
LSS390955	Deluxe Hygiene Access Sling with Head Support - Polyester - Clip - X-Large	●	300kg

Deluxe Hygiene Access Sling is registered in the ARTG, AUST R ARTG 224719



## DELUXE GENERAL PURPOSE SLING WITH HEAD SUPPORT

Code	Description	Edging	S.W.L
LSS390740	Deluxe General Purpose Sling with Head Support - Polyester - Loop - Small	●	200kg
LSS390745	Deluxe General Purpose Sling with Head Support - Polyester - Loop - Medium	●	200kg
LSS390750	Deluxe General Purpose Sling with Head Support - Polyester - Loop - Large	●	300kg
LSS390755	Deluxe General Purpose Sling with Head Support - Polyester - Loop - X-Large	●	300kg
LSS390751	Deluxe General Purpose Sling with Head Support - Polyester - Loop - XX-Large	●	300kg
LSS390752	Deluxe General Purpose Sling with Head Support - Polyester - Loop - XXX-Large	●	300kg
LSS390756	Deluxe General Purpose Sling with Head Support - Mesh - Loop - Small	●	200kg
LSS390757	Deluxe General Purpose Sling with Head Support - Mesh - Loop - Medium	●	200kg
LSS390758	Deluxe General Purpose Sling with Head Support - Mesh - Loop - Large	●	300kg
LSS390759	Deluxe General Purpose Sling with Head Support - Mesh - Loop - X-Large	●	300kg
LSS3907591	Deluxe General Purpose Sling with Head Support - Mesh - Loop - XX-Large	●	300kg
LSS3907592	Deluxe General Purpose Sling with Head Support - Mesh - Loop - XXX-Large	●	300kg
LSS390900	Deluxe General Purpose Sling with Head Support - Polyester - Clip - Small	●	200kg
LSS390905	Deluxe General Purpose Sling with Head Support - Polyester - Clip - Medium	●	200kg
LSS390910	Deluxe General Purpose Sling with Head Support - Polyester - Clip - Large	●	300kg
LSS390915	Deluxe General Purpose Sling with Head Support - Polyester - Clip - X-Large	●	300kg
LSS390916	Deluxe General Purpose Sling with Head Support - Mesh - Clip - Small	●	200kg
LSS390917	Deluxe General Purpose Sling with Head Support - Mesh - Clip - Medium	●	200kg
LSS390918	Deluxe General Purpose Sling with Head Support - Mesh - Clip - Large	●	300kg
LSS390919	Deluxe General Purpose Sling with Head Support - Mesh - Clip - X-Large	●	300kg

Deluxe General Purpose Sling is registered in the ARTG, AUST R ARTG 224718



## DELUXE HAMMOCK SLING WITH HEAD SUPPORT

Code	Description	Edging	S.W.L
LSS390800	Deluxe Hammock Sling with Head Support - Super Soft - Loop - Small	●	200kg
LSS390805	Deluxe Hammock Sling with Head Support - Super Soft - Loop - Medium	●	200kg
LSS390810	Deluxe Hammock Sling with Head Support - Super Soft - Loop - Large	●	300kg
LSS390815	Deluxe Hammock Sling with Head Support - Super Soft - Loop - X-Large	●	300kg
LSS390860	Deluxe Hammock Sling with Head Support - Mesh - Loop - Small	●	200kg
LSS390865	Deluxe Hammock Sling with Head Support - Mesh - Loop - Medium	●	200kg
LSS390870	Deluxe Hammock Sling with Head Support - Mesh - Loop - Large	●	300kg
LSS390875	Deluxe Hammock Sling with Head Support - Mesh - Loop - X-Large	●	300kg

Deluxe Hammock Sling is registered in the ARTG, AUST R ARTG 224720



## DELUXE LOW FRICTION SLING

Code	Description	Edging	S.W.L
LSS390880	Deluxe Low Friction Sling - Parasiik - Loop - Small	●	200kg
LSS390885	Deluxe Low Friction Sling - Parasiik - Loop - Medium	●	200kg
LSS390890	Deluxe Low Friction Sling - Parasiik - Loop - Large	●	300kg
LSS390895	Deluxe Low Friction Sling - Parasiik - Loop - X-Large	●	300kg
LSS390960	Deluxe Low Friction Sling - Parasiik - Clip - Small	●	200kg
LSS390965	Deluxe Low Friction Sling - Parasiik - Clip - Medium	●	200kg
LSS390970	Deluxe Low Friction Sling - Parasiik - Clip - Large	●	300kg
LSS390975	Deluxe Low Friction Sling - Parasiik - Clip - X-Large	●	300kg

Deluxe Low Friction Sling (Loop) is registered in the ARTG, AUST R ARTG 224720

Deluxe Low Friction Sling (Clip) is registered in the ARTG, AUST R ARTG 224718



## DELUXE HYGIENE ACCESS SLING

Code	Description	Edging	S.W.L
LSS390760	Deluxe Hygiene Access Sling - Polyester - Loop - Small	●	200kg
LSS390765	Deluxe Hygiene Access Sling - Polyester - Loop - Medium	●	200kg
LSS390770	Deluxe Hygiene Access Sling - Polyester - Loop - Large	●	300kg
LSS390775	Deluxe Hygiene Access Sling - Polyester - Loop - X-Large	●	300kg
LSS390776	Deluxe Hygiene Access Sling - Polyester - Loop - XX-Large	●	300kg
LSS390777	Deluxe Hygiene Access Sling - Polyester - Loop - XXX-Large	●	300kg

Deluxe Hygiene Access Sling is registered in the ARTG, AUST R ARTG 224719

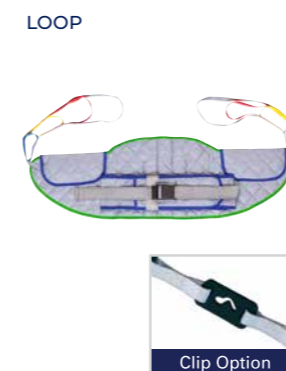

## DELUXE STANDING SLING

Code	Description	Edging	S.W.L
LSS390720	Deluxe Padded Standing Sling - Polyester - Loop - Small	●	200kg
LSS390725	Deluxe Padded Standing Sling - Polyester - Loop - Medium	●	200kg
LSS390730	Deluxe Padded Standing Sling - Polyester - Loop - Large	●	300kg
LSS390735	Deluxe Padded Standing Sling - Polyester - Loop - X-Large	●	300kg
LSS390736	Deluxe Padded Standing Sling - Polyester - Loop - XX-Large	●	300kg
LSS390737	Deluxe Padded Standing Sling - Polyester - Loop - XXX-Large	●	300kg
LSS390920	Deluxe Padded Standing Sling - Polyester - Clip - Small	●	200kg
LSS390925	Deluxe Padded Standing Sling - Polyester - Clip - Medium	●	200kg
LSS390930	Deluxe Padded Standing Sling - Polyester - Clip - Large	●	300kg
LSS390935	Deluxe Padded Standing Sling - Polyester - Clip - X-Large	●	300kg

Deluxe Standing Sling is registered in the ARTG, AUST R ARTG 224698

# ASSOCIATED PRODUCTS



## SINGLE USE SLINGS



Intuitive usage indicator identifies when sling has been wet or washed, rendering it no longer available for use.

- - LSS391100-Aspire Single Use Patient Sling Small
- - LSS391110-Aspire Single Use Patient Sling Medium
- - LSS391120-Aspire Single Use Patient Sling Large
- - LSS391130-Aspire Single Use Patient Sling Extra Large

Non woven fabric  
SWL 200kg, 1 year warranty,



## MOBILITY SCOOTERS

Wide range of Aspire Scooters for all user needs.

*Shown: Aspire HS268 Manual Folding Mobility Scooter SCT671135*



## LIFT CHAIR RECLINERS

Luxury Aspire recliner range has four, dual and single motor functions.

*Shown: Aspire Raphael Quattro Powerlift Recline Chair Sizes S-XL Available*



## AIDACARE SLING AUDITING

**Old Slings? Don't risk it.**

An old, worn out or faulty sling could be a significant safety risk for your organisation.

Aidacare's Sling Audit Program can assist you to ensure your sling inventory is in safe working order at all times.

Periodic sling audits are now a mandatory accreditation requirement. Ask us how we can help you manage the risk in this area of your business.